

Scilab Manual for
Control Theory
by Prof Shweta Gaur
Instrumentation Engineering
Dharmsinh Desai University¹

Solutions provided by
Prof Shweta Gaur
Instrumentation Engineering
Dharmsinh Desai University

June 20, 2026

¹Funded by a grant from the National Mission on Education through ICT, <http://spoken-tutorial.org/NMEICT-Intro>. This Scilab Manual and Scilab codes written in it can be downloaded from the "Migrated Labs" section at the website <http://scilab.in>

Contents

List of Scilab Solutions	3
1 Introduction to Control Systems	8
2 Transfer Function	12
3 Mathematical Modelling	18
4 Signal Flow Graph	20
5 Block Diagram Reduction Techniques	28
6 Feedback Characteristics	31
7 Time Response Analysis	37
8 Stability of Control Systems	43
9 Root Locus	49
10 Frequency Response Analysis	64
11 Polar Plots	69
12 Nyquist Plots	82
13 Bode Plots	97

List of Experiments

Solution 1.5	To find Laplace Transform of given function	8
Solution 1.6	To find Inverse Laplace Transform of given function	9
Solution 1.7	To find Response of given system with respect to Step input	9
Solution 1.8	To find Response of given system with respect to Ramp input	10
Solution 2.3	To find Transfer function of given system	12
Solution 2.4	To find Transfer function of given system	13
Solution 2.5	To find Transfer function of given system	14
Solution 2.6	To find Transfer function of given system	15
Solution 2.7	To find Transfer function of given system	16
Solution 3.4	To find Reflected Inertia and Reflected Coulomb Friction for given gear train system	18
Solution 3.5	To find Transfer function of Mass spring system .	19
Solution 4.7	To obtain Transfer function using Masons gain for- mula	20
Solution 4.8	To obtain Transfer function using Masons gain for- mula	21
Solution 4.9	To obtain Transfer function using Masons gain for- mula	22
Solution 4.10	To obtain Transfer function using Masons gain for- mula	23
Solution 4.11	To obtain Transfer function using Masons gain for- mula	24
Solution 4.12	To obtain Transfer function using Masons gain for- mula	25
Solution 4.13	To obtain Transfer function using Masons gain for- mula	26

Solution 4.14	To obtain Transfer function using Masons gain formula	27
Solution 5.7	To solve Cascade of two functions	28
Solution 5.8	To solve Parallel combination of two functions	29
Solution 5.9	To find Transfer function for a closed loop	29
Solution 6.6	To find sensitivity of given system	31
Solution 6.7	To find sensitivity of given system	32
Solution 6.8	To find sensitivity of given system	32
Solution 6.9	To find sensitivity of given system	34
Solution 6.10	To find sensitivity of given system	34
Solution 6.11	To find sensitivity of given system	35
Solution 7.6	To find Time response parameters for the given system	37
Solution 7.7	To find Time response parameters for the given system	38
Solution 7.8	To find Time response parameters for the given system	39
Solution 7.9	To find Time response parameters for the given system	41
Solution 8.6	To find stability of given system using Routh Hurwitz criteria	43
Solution 8.7	To find stability of given system using Routh Hurwitz criteria	44
Solution 8.8	To find value of K for marginal stability of given system	45
Solution 8.9	To find value of K for marginal stability of given system	46
Solution 8.10	To find value of K for marginal stability of given system	47
Solution 9.3	To sketch Root locus of given system	49
Solution 9.4	To sketch Root locus of given system	52
Solution 9.5	To sketch Root locus of given system	52
Solution 9.6	To sketch Root locus of given system	54
Solution 9.7	To sketch Root locus of given system	56
Solution 9.8	To sketch Root locus of given system	56
Solution 9.9	To sketch Root locus of given system	58
Solution 9.10	To sketch Root locus of given system	60
Solution 9.11	To sketch Root locus of given system	60

Solution 9.12	To sketch Root locus of given system	62
Solution 10.5	To find Frequency domain specifications for the given system	64
Solution 10.6	To find Frequency domain specifications for the given system	65
Solution 10.7	To find Frequency domain specifications for the given system	66
Solution 10.8	To find Frequency domain specifications for the given system	67
Solution 11.3	To obtain Polar plot of given system	69
Solution 11.4	To obtain Polar plot of given system	72
Solution 11.5	To obtain Polar plot of given system	72
Solution 11.6	To obtain Polar plot of given system	74
Solution 11.7	To obtain Polar plot of given system	75
Solution 11.8	To obtain Polar plot of given system	76
Solution 11.9	To obtain Polar plot of given system	78
Solution 11.10	To obtain Polar plot of given system	79
Solution 11.11	To obtain Polar plot of given system	80
Solution 12.3	To obtain Nyquist plot of given system	82
Solution 12.4	To obtain Nyquist plot of given system	82
Solution 12.5	To obtain Nyquist plot of given system	85
Solution 12.6	To obtain Nyquist plot of given system	88
Solution 12.7	To obtain Nyquist plot of given system	88
Solution 12.8	To obtain Nyquist plot of given system	90
Solution 12.9	To obtain Nyquist plot of given system	92
Solution 12.10	To obtain Nyquist plot of given system	92
Solution 12.11	To obtain Nyquist plot of given system	94
Solution 12.12	To obtain Nyquist plot of given system	95
Solution 13.3	To obtain Bode plot of given system	97
Solution 13.4	To obtain Bode plot of given system	99
Solution 13.5	To obtain Bode plot of given system	100
Solution 13.6	To obtain Bode plot of given system	101
Solution 13.7	To obtain Bode plot of given system	103
Solution 13.8	To obtain Bode plot of given system	104
Solution 13.9	To obtain Bode plot of given system	106
Solution 13.10	To obtain Bode plot of given system	107
Solution 13.11	To obtain Bode plot of given system	109
Solution 13.12	To obtain Bode plot of given system	110

List of Figures

9.1	To sketch Root locus of given system	50
9.2	To sketch Root locus of given system	51
9.3	To sketch Root locus of given system	53
9.4	To sketch Root locus of given system	54
9.5	To sketch Root locus of given system	55
9.6	To sketch Root locus of given system	57
9.7	To sketch Root locus of given system	58
9.8	To sketch Root locus of given system	59
9.9	To sketch Root locus of given system	61
9.10	To sketch Root locus of given system	62
11.1	To obtain Polar plot of given system	70
11.2	To obtain Polar plot of given system	71
11.3	To obtain Polar plot of given system	73
11.4	To obtain Polar plot of given system	74
11.5	To obtain Polar plot of given system	75
11.6	To obtain Polar plot of given system	77
11.7	To obtain Polar plot of given system	78
11.8	To obtain Polar plot of given system	79
11.9	To obtain Polar plot of given system	81
12.1	To obtain Nyquist plot of given system	83
12.2	To obtain Nyquist plot of given system	84
12.3	To obtain Nyquist plot of given system	86
12.4	To obtain Nyquist plot of given system	87
12.5	To obtain Nyquist plot of given system	89
12.6	To obtain Nyquist plot of given system	90
12.7	To obtain Nyquist plot of given system	91
12.8	To obtain Nyquist plot of given system	93

12.9 To obtain Nyquist plot of given system	94
12.10 To obtain Nyquist plot of given system	95
13.1 To obtain Bode plot of given system	98
13.2 To obtain Bode plot of given system	99
13.3 To obtain Bode plot of given system	100
13.4 To obtain Bode plot of given system	102
13.5 To obtain Bode plot of given system	103
13.6 To obtain Bode plot of given system	105
13.7 To obtain Bode plot of given system	106
13.8 To obtain Bode plot of given system	108
13.9 To obtain Bode plot of given system	109
13.10 To obtain Bode plot of given system	111

Experiment: 1

Introduction to Control Systems

Scilab code Solution 1.5 To find Laplace Transform of given function

```
1 // OS : Windows 7
2 // Scilab : 5.4.1
3 // Toolboxes : Maxima 5.20.1 and ActivePerl 5.20.2
4
5 // Exercise 5 of Lab 1
6 // To find Laplace Transform of given function f(t)
   = sin(2*t)*cos(3*t)
7
8 clc
9 close
10
11 syms t s
12 F=laplace (sin(2*t)*cos(2*t),t,s)
13 disp (F,"F( s )=")
```

Scilab code Solution 1.6 To find Inverse Laplace Transform of given function

```
1 // OS : Windows 7
2 // Scilab : 5.4.1
3 // Toolboxes : Maxima 5.20.1 and ActivePerl 5.20.2
4
5 // Exercise 6 of Lab 1
6 // To find Inverse Laplace Transform of given
   function F(s)=56*s/(s^4+106*s^2+2025)
7
8 clc
9 close
10
11 syms s t
12 F=56*s/(s^4+106*s^2+2025)
13 f=ilaplace(F,s,t)
14 disp (f," f ( t )=")
```

Scilab code Solution 1.7 To find Response of given system with respect to Step input

```
1 // OS : Windows 7
2 // Scilab : 5.4.1
3 // Toolboxes : Maxima 5.20.1 and ActivePerl 5.20.2
4
5 // Exercise 7 of Lab 1
```

```

6 // To find Response of given system w.r.t. Step
  input
7
8 clc
9 close
10
11 syms t s
12
13 TF=5/(s^2+6*s+101)
14 R=1/s
15
16 C=R*TF
17
18 disp(C,"Response = ")

```

Scilab code Solution 1.8 To find Response of given system with respect to Ramp input

```

1 // OS : Windows 7
2 // Scilab : 5.4.1
3 // Toolboxes : Maxima 5.20.1 and ActivePerl 5.20.2
4
5 // Exercise 8 of Lab 1
6 // To find Response of given system w.r.t. Ramp
  input
7
8 clc
9 close
10
11 syms t s
12
13 TF=10/((s+2)*(s+3))
14 R=1/s^2

```

```
15
16 C=R*TF
17
18 disp(C," Response = ")
```

Experiment: 2

Transfer Function

Scilab code **Solution 2.3** To find Transfer function of given system

```
1 // OS : Windows 7
2 // Scilab : 5.4.1
3 // Toolboxes : Maxima 5.20.1 and ActivePerl 5.20.2
4
5 // Exercise 3 of Lab 2
6 // To find Transfer function of given system
7
8 clc
9 close
10
11 syms s
12
13 z1=-2
14 p1=-1
15 p2=0
16 p3=-3
17
18 tf=(s-z1)/((s-p1)*(s-p2)*(s-p3))
19 disp(tf,"Transfer function = ")
```

Scilab code Solution 2.4 To find Transfer function of given system

```
1 // OS : Windows 7
2 // Scilab : 5.4.1
3 // Toolboxes : Maxima 5.20.1 and ActivePerl 5.20.2
4
5 // Exercise 4 of Lab 2
6 // To find Transfer function of given system
7
8 clc
9 close
10
11 syms s R1 R2 C1 C2
12
13 //Preparing SFG for given circuit
14 //i1=(ei-V1)/R1
15 //V1=(i1-i2)*(1/(C1*s))
16 //i2=(V1-e0)/R2
17 //e0=i2*(1/(C2*s))
18
19 //Using Masons gain formula
20 P1=(1/R1)*(1/(C1*s))*(1/R2)*(1/(C2*s))
21 L1=(1/(C1*s))*(-1/R1)
22 L2=(1/R2)*(-1/(C1*s))
23 L3=(1/(C2*s))*(-1/R2)
24 L11=L1*L3
25 del1=1
26 del=1-(L1+L2+L3)+L11
27 tf=P1*del1/del
28 disp(tf,"Transfer function = ")
```

Scilab code Solution 2.5 To find Transfer function of given system

```
1
2
3
4
5
6 // OS : Windows 7
7 // Scilab : 5.4.1
8 // Toolboxes : Maxima 5.20.1 and ActivePerl 5.20.2
9
10 // Exercise 5 of Lab 2
11 // To find Transfer function of given system
12
13 clc
14 close
15
16 syms s R1 R2 C
17
18 //Preparing SFG for given circuit
19 // $i_1 = (e_i - V_1) / R_1$ 
20 // $e_i = R_1 * i_1 + R_2 * i_1 + (1 / (C * s)) * i_1$ 
21 // $V_1 = i_1 * (R_2 + (1 / (C * s)))$ 
22 // $e_2 = V_1$ 
23
24 //Using Masons gain formula
25  $P_1 = (1 / R_1) * (R_2 + (1 / (C * s))) * 1$ 
26  $L_1 = (R_2 + (1 / (C * s))) * (-1 / R_1)$ 
27  $del = 1 - L_1$ 
28  $del_1 = 1$ 
29
30  $tf = P_1 * del_1 / del$ 
```

```
31 disp(tf," Transfer function = ")
```

Scilab code Solution 2.6 To find Transfer function of given system

```
1 // OS : Windows 7
2 // Scilab : 5.4.1
3 // Toolboxes : Maxima 5.20.1 and ActivePerl 5.20.2
4
5 // Exercise 6 of Lab 2
6 // To find Transfer function of given system
7
8 clc
9 close
10
11 syms s R1 R2 R3 R4 L1 L2 L3
12
13 //Preparing SFG for given circuit
14 //i1=(ei-V1)/(R1+L1*s)
15 //V1=(i1-i2)*(R2+L2*s)
16 //i2=(V1-e0)/(R3+L3*s)
17 //e0=R4*i2
18
19 //Using Masons gain formula
20 P1=R4*(1/(R1+L1*s))*(R2+L2*s)*(1/(R3+L3*s))
21 L1=-((R2+L2*s)/(R1+L1*s))
22 L2=-((R2+L2*s)/(R3+L3*s))
23 L3=-R4/(R3+L3*s)
24 L11=L1*L3
25 del1=1
26 del=1-(L1+L2+L3)+L11
27
28 tf=P1*del1/del
29 disp(tf," Transfer function = ")
```

Scilab code Solution 2.7 To find Transfer function of given system

```
1 // OS : Windows 7
2 // Scilab : 5.4.1
3 // Toolboxes : Maxima 5.20.1 and ActivePerl 5.20.2
4
5 // Exercise 7 of Lab 2
6 // To find Transfer function of given system
7
8 clc
9 close
10
11 syms s R1 R2 Rb C1 C2 L1 L2
12
13 //Preparing SFG for given circuit
14 //i1=(ei-V1)/Rb
15 //V1=(i1-i2)*(1/(C1*s))+V2
16 //i2=(V1-e0)/(R1+L1*s)
17 //V2=i1*(R2+L2*s)
18 //e0-V2=i2/(C2*s)
19
20 //Using Masons gain formula
21 P1=(1/Rb)*(1/(C1*s))*(1/(R1+L1*s))*(1/(C2*s))
22 P2=(1/Rb)*(R2+L2*s)*1
23 L1=(1/(C1*s))*(-1/Rb)
24 L2=(1/(R1+L1*s))*(-1/(C1*s))
25 L3=(1/(C2*s))*(-1/(R1+L1*s))
26 L4=(R2+L2*s)*1*(-1/Rb)
27 L5=(R2+L2*s)*1*(-1/(R1*L1*s))*(-1/(C1*s))*(-1/Rb)
28 L11=L1*L3
29
30 del1=1
```

```
31 del2=1-L2
32 del=1-(L1+L2+L3+L4+L5)+L11
33 tf=(P1*del1+P2*del2)/del
34 disp(tf,"Transfer function = ")
```

Experiment: 3

Mathematical Modelling

Scilab code Solution 3.4 To find Reflected Inertia and Reflected Coulomb Friction for given gear train system

```
1 // OS : Windows 7
2 // Scilab : 5.4.1
3 // Toolboxes : Maxima 5.20.1 and ActivePerl 5.20.2
4
5 // Exercise 4 of Lab 3
6 // To find Reflected Inertia and Reflected Coulomb
   Friction for given gear train system
7
8 clc
9 close
10
11 J2=0.08;
12 T2=5;
13 teeth_ratio=1/10
14 J1=(teeth_ratio)^2*J2;
15 T1=(teeth_ratio)*T2
16
17 printf(" Reflected Inertia = %f oz-in.-sec3\n",J1)
```

```
18 printf(" Reflected Coulumb Friction = %f oz-in.\n",T1
    )
```

Scilab code Solution 3.5 To find Transfer function of Mass spring system

```
1 // OS : Windows 7
2 // Scilab : 5.4.1
3 // Toolboxes : Maxima 5.20.1 and ActivePerl 5.20.2
4
5 // Exercise 5 of Lab 3
6 // To find Transfer function of Mass spring system
7
8 clc
9 close
10
11 syms K M B
12 s=%s
13 P1=(1/M)*(s^-2)
14 L11=-(B/M)*(s^-1)
15 L21=-(K/M)*(s^-2)
16 del=1-(L11+L21)
17 del1=1
18 tf=P1*del1/del
19 disp(tf," Transfer function = ")
```

Experiment: 4

Signal Flow Graph

Scilab code Solution 4.7 To obtain Transfer function using Masons gain formula

```
1 // OS : Windows 7
2 // Scilab : 5.4.1
3 // Toolboxes : Maxima 5.20.1 and ActivePerl 5.20.2
4
5 // Exercise 7 of Lab 4
6 // To obtain Transfer function using Mason's gain
   formula
7
8 clc
9 close
10
11 syms g1 g2 g3 g4 h1 h2
12
13 p1=g1*g2*g3
14 p2=g4
15 l1=-g2*h1
16 l2=g1*g2*h1
17 l3=-(g3*g2*h2)
```

```

18 d=1-(l1+l2+l3)
19 d1=1
20 d2=d
21 tf=(p1*d1+p2*d2)/(d)
22
23 disp(tf,"Transfer funtion = ")

```

Scilab code Solution 4.8 To obtain Transfer function using Masons gain formula

```

1 // OS : Windows 7
2 // Scilab : 5.4.1
3 // Toolboxes : Maxima 5.20.1 and ActivePerl 5.20.2
4
5 // Exercise 8 of Lab 4
6 // To obtain Transfer function using Mason's gain
   formula
7
8 clc
9 close
10
11 syms g1 g2 g3 g4 h1 h2
12
13 p1=g1*g3
14 p2=g1*g2
15 p3=g1*g3*g4*h2
16 p4=g1*g2*g4*h2
17 d1=1
18 d2=1
19 d3=1
20 d4=1
21 l1=-g1*g3*h1*h2
22 l2=-g1*g2*h1*h2

```

```

23 d=1-(l1+l2)
24 tf=(p1*d1+p2*d2+p3*d3+p4*d4)/d
25
26 disp(tf,"Transfer function = ")

```

Scilab code Solution 4.9 To obtain Transfer function using Masons gain formula

```

1 // OS : Windows 7
2 // Scilab : 5.4.1
3 // Toolboxes : Maxima 5.20.1 and ActivePerl 5.20.2
4
5 // Exercise 9 of Lab 4
6 // To obtain Transfer function using Mason's gain
  formula
7
8 clc
9 close
10
11 syms g1 g2 g3 g4 g5 g6 g7 g8 h1 h2
12
13 p1=g2*g4*g6
14 p2=g3*g5*g7
15 p3=g2*g1*g7
16 p4=g3*g6*g8
17 p5=-g2*g1*h2*g8*g6
18 p6=-g3*g8*h1*g1*g7
19 l1=-g4*h1
20 l2=-g5*h2
21 l3=g1*h2*g8*h1
22 d=1+g4*h1+g5*h2-g1*h2*g8*h1+g4*h1*g5*h2
23 d1=1+g5*h2
24 d2=1+g4*h1

```

```

25 d3=1
26 d4=1
27 d5=1
28 d6=1
29 tf=(p1*d1+p2*d2+p3*d3+p4*d4+p5*d5+p6*d6)/d
30
31 disp(tf,"Transfer function = ")

```

Scilab code Solution 4.10 To obtain Transfer function using Masons gain formula

```

1 // OS : Windows 7
2 // Scilab : 5.4.1
3 // Toolboxes : Maxima 5.20.1 and ActivePerl 5.20.2
4
5 // Exercise 10 of Lab 4
6 // To obtain Transfer function using Mason's gain
   formula
7
8 clc
9 close
10
11 syms t1 t2 t3 q1 q2 s
12 p1=t1/(s*(s+q1))
13 p2=t2/(s+q1)
14 p3=t3
15 l1=q2/(s*(s+q1))
16 d=1+(q2/(s*(s+q1)))
17 d1=1
18 d2=1
19 d3=1+(q2/(s*(s+q1)))
20 tf=(p1*d1+p2*d2+p3*d3)/d
21

```

```
22 disp(tf," Transfer function = ")
```

Scilab code Solution 4.11 To obtain Transfer function using Masons gain formula

```
1 // OS : Windows 7
2 // Scilab : 5.4.1
3 // Toolboxes : Maxima 5.20.1 and ActivePerl 5.20.2
4
5 // Exercise 11 of Lab 4
6 // To obtain Transfer function using Mason's gain
   formula
7
8 clc
9 close
10
11 syms g1 g2 g3 g4 h1 h2
12
13 p1=g1*g2*g3
14 p2=g1*g4
15 l1=-g1*g2*h1
16 l2=-g2*g3*h2
17 l3=-g1*g2*g3
18 l4=-g4*h2
19 l5=-g4*g1
20 d=1+g1*g2*h1+g2*g3*h2+g1*g2*g3+g4*h2+g1*g4
21 d1=1
22 d2=1
23 tf=(p1*d1+p2*d2)/(d)
24
25 disp(tf," Transfer function = ")
```

Scilab code Solution 4.12 To obtain Transfer function using Mason's gain formula

```
1 // OS : Windows 7
2 // Scilab : 5.4.1
3 // Toolboxes : Maxima 5.20.1 and ActivePerl 5.20.2
4
5 // Exercise 12 of Lab 4
6 // To obtain Transfer function using Mason's gain
   formula
7
8 clc
9 close
10
11 syms g1 g2 g3 g4 h1 h2
12
13 p1=g1*g2*g3
14 p2=g4
15 l1=-g1*g2*h1
16 l2=-g1*g2*g3
17 l3=-g2*g3*h2
18 l4-g4
19 l5=g4*h2*g2*h1
20 d=1-(l1+l2+l3+l4+l5)
21 d1=1
22 d2=1
23 tf=(p1*d1+p2*d2)/d
24
25 disp(tf," Transfer function = ")
```

Scilab code Solution 4.13 To obtain Transfer function using Masons gain formula

```
1 // OS : Windows 7
2 // Scilab : 5.4.1
3 // Toolboxes : Maxima 5.20.1 and ActivePerl 5.20.2
4
5 // Exercise 13 of Lab 4
6 // To obtain Transfer function using Mason's gain
   formula
7
8 clc
9 close
10
11 syms g1 g2 g3 g4 h1 h2 h3 h4
12
13 p1=g1*g2*g3
14 p2=g4*g3
15 l1=g3*g4*h1*h2
16 l2=g1*g2*g3*h1*h2
17 l3=-g1*h2*h3
18 d=1+g1*h2*h3-g3*g4*h1*h2-g1*g2*g3*h1*h2
19 d1=1
20 d2=1
21 tf=(p1*d1+p2*d2)/d
22
23 disp(tf,"Transfer function = ")
```

Scilab code Solution 4.14 To obtain Transfer function using Masons gain formula

```
1 // OS : Windows 7
2 // Scilab : 5.4.1
3 // Toolboxes : Maxima 5.20.1 and ActivePerl 5.20.2
4
5 // Exercise 14 of Lab 4
6 // To obtain Transfer function using Mason's gain
   formula
7
8 clc
9 close
10
11 syms g1 g2 g3 g4 g5 g6 g7 g8 g9
12
13 p1=g1*g2
14 p2=g4
15 p3=g7*g8
16 p4=g1*g5*g8
17 p5=g7*g6*g2
18 l1=g9
19 l2=g3
20 l3=g5*g6
21 d=1-(g3+g9+g5*g6)+g9*g3
22 d1=1-g9
23 d2=1-(g9+g3+g5*g6)+g9*g3
24 d3=1-g3
25 d4=1
26 d5=1
27 tf=(p1*d1+p2*d2+p3*d3+p4*d4+p5*d5)/d
28
29 disp(tf," Transfer function = ")
```

Experiment: 5

Block Diagram Reduction Techniques

Scilab code Solution 5.7 To solve Cascade of two functions

```
1 // OS : Windows 7
2 // Scilab : 5.4.1
3 // Toolboxes : Maxima 5.20.1 and ActivePerl 5.20.2
4
5 // Exercise 7 of Lab 1
6 // To solve Cascade of two functions
7 clc
8 close
9
10 syms s
11
12  $G1=5/(s*(s^2+s+2))$ 
13  $G2=(5*s+3)/((s+1)*(s+2))$ 
14  $G=G1*G2$ 
15
16 disp(G,"Resultant function G(s) = ")
```

Scilab code Solution 5.8 To solve Parallel combination of two functions

```
1 // OS : Windows 7
2 // Scilab : 5.4.1
3 // Toolboxes : Maxima 5.20.1 and ActivePerl 5.20.2
4
5 // Exercise 8 of Lab 1
6 // To solve Parallel combination of two functions
7 clc
8 close
9
10 syms s
11
12 G1=19/((s+5)*(s+99))
13 G2=(10*s+9)/((s+3)*(s+5))
14 G=G1/G2
15
16 disp(G,"Resultant function G(s) = ")
```

Scilab code Solution 5.9 To find Transfer function for a closed loop

```
1 // OS : Windows 7
2 // Scilab : 5.4.1
3 // Toolboxes : Maxima 5.20.1 and ActivePerl 5.20.2
4
5 // Exercise 9 of Lab 1
6 // To find Transfer function for a closed loop
7 clc
```

```
8 close
9
10 syms s
11
12 G=10/(s*(s+20))
13 H=2
14 TF=G/(1+G*H)
15
16 disp(TF,"Transfer function = ")
```

Experiment: 6

Feedback Characteristics

Scilab code Solution 6.6 To find sensitivity of given system

```
1 // OS : Windows 7
2 // Scilab : 5.4.1
3 // Toolboxes : Maxima 5.20.1 and ActivePerl 5.20.2
4
5 // Exercise 6 of Lab 6
6 // To find sensitivity of given system
7
8 clc
9 close
10
11 funcprot(0);
12 s=%i;
13 h=.25;
14 g=25/(s^2+s)
15 sg_complex=1/(1+g*h)
16 sg=abs(sg_complex)
17 disp(sg,"Sensitivity with respect to G=")
18 sh_complex=(-g*h/(1+g*h))
19 sh=abs(sh_complex)
```

```
20 disp(sh," Sensitivity with respect to H=")
```

Scilab code Solution 6.7 To find sensitivity of given system

```
1 // OS : Windows 7
2 // Scilab : 5.4.1
3 // Toolboxes : Maxima 5.20.1 and ActivePerl 5.20.2
4
5 // Exercise 7 of Lab 6
6 // To find sensitivity of given system
7
8 clc
9 close
10
11 funcprot(0);
12 s=%i*2;
13 h=1;
14 g=5/(s^2+s*2)
15 sg_complex=1/(1+g*h)
16 sg=abs(sg_complex)
17 disp(sg," Sensitivity with respect to G=")
18 sh_complex=(-g*h/(1+g*h))
19 sh=abs(sh_complex)
20 disp(sh," Sensitivity with respect to H=")
```

Scilab code Solution 6.8 To find sensitivity of given system

```
1 // OS : Windows 7
2 // Scilab : 5.4.1
```

```

3 // Toolboxes : Maxima 5.20.1 and ActivePerl 5.20.2
4
5 // Exercise 8 of Lab 6
6 // To find sensitivity of given system
7
8 clc
9 close
10
11 // FOR w=1 rad/sec;
12 funcprot(0);
13 s=1*%i;
14 h=10;
15 g=10/(s^2+s)
16 sg_complex=1/(1+g*h)
17 sg=abs(sg_complex)
18 disp("For w=1 rad/sec")
19 disp(sg, "Sensitivity with respect to G=")
20 sh_complex=(-g*h/(1+g*h))
21 sh=abs(sh_complex)
22 disp(sh, "Sensitivity with respect to H=")
23
24 // FOR w=2 rad/sec;
25 funcprot(0);
26 s=2*%i;
27 h=10;
28 g=10/(s^2+s)
29 sg_complex=1/(1+g*h)
30 sg=abs(sg_complex)
31 disp("For w=2 rad/sec")
32 disp(sg, "Sensitivity with respect to G=")
33 sh_complex=(-g*h/(1+g*h))
34 sh=abs(sh_complex)
35 disp(sh, "Sensitivity with respect to H=")

```

Scilab code Solution 6.9 To find sensitivity of given system

```
1 // OS : Windows 7
2 // Scilab : 5.4.1
3 // Toolboxes : Maxima 5.20.1 and ActivePerl 5.20.2
4
5 // Exercise 9 of Lab 6
6 // To find sensitivity of given system
7
8 clc
9 close
10
11 funcprot(0);
12 s=1*%i;
13 h=1;
14 k=1;
15 g=k/(s^2+15*s)
16 deff('t=f(k,s) ', 't=k/(s^2+15*s+k) ');
17 sg_complex=(derivative(f,k))*(k/(k/(s^2+15*s+k)))
18 sg=abs(sg_complex)
19 disp(sg,"Sensitivity with respect to K=")
```

Scilab code Solution 6.10 To find sensitivity of given system

```
1 // OS : Windows 7
2 // Scilab : 5.4.1
3 // Toolboxes : Maxima 5.20.1 and ActivePerl 5.20.2
4
5 // Exercise 10 of Lab 6
6 // To find sensitivity of given system
7
8 clc
9 close
```

```

10
11 funcprot(0);
12 s=%i;
13 T=input("enter the value of T=") // we will ask
    user to input the value of 'T'
14 h=1;
15 k=10;
16 g=k/(T*s+1)
17 sg_complex=1/(1+g*h)
18 sg=abs(sg_complex)
19 disp(sg,"Sensitivity with respect to G=")

```

Scilab code Solution 6.11 To find sensitivity of given system

```

1 // OS : Windows 7
2 // Scilab : 5.4.1
3 // Toolboxes : Maxima 5.20.1 and ActivePerl 5.20.2
4
5 // Exercise 11 of Lab 6
6 // To find sensitivity of given system
7
8 clc
9 close
10
11 funcprot(0);
12 s=.5*i;
13 h=1;
14 k=1;
15 g=25*k/(s^2+5*s)
16 sg_complex=1/(1+g*h)
17 sg=abs(sg_complex)
18
19 disp(sg,"Sensitivity with respect to G=")

```

```
20 sh_complex=(-g*h/(1+g*h))
21 sh=abs(sh_complex)
22 disp(sh,"    Sensitivity with respect to H=")
```

Experiment: 7

Time Response Analysis

Scilab code Solution 7.6 To find Time response parameters for the given system

```
1 // OS : Windows 7
2 // Scilab : 5.4.1
3 // Toolboxes : Maxima 5.20.1 and ActivePerl 5.20.2
4
5 // Exercise 6 of Lab 7
6 // To find Time response parameters for the given
  system
7
8 clc
9 close
10
11 s=poly(0, 's');
12 g=100/(s^2+10*s)
13 tf=g/(1+g)
14
15 // To compare tf with  $W_n^2/(s^2+2*\zeta*W_n+W_n^2)$ 
16 y=denom(tf)
17 q=numer(tf)
```

```

18 z=coeff(y)
19 r=coeff(q)
20 wn=sqrt(r)
21
22 zeta=z(1,2)/(2*wn)
23 wd=(wn*sqrt(1-zeta^2))
24 mp=((%e^(-%pi*zeta/(sqrt(1-zeta^2))))*100)
25 theta=atan(sqrt(1-zeta^2)/zeta);
26 tr=(%pi-theta)/wd)
27 tp=(%pi/wd)
28 ts=(4/(zeta*wn))
29
30 printf("Undamped natural frequency = %f rad/sec \n",
        wn)
31 printf("Damping ratio = %f \n",zeta)
32 printf("Damped frequency = %f rad/sec \n",wd)
33 printf("Maximum Peak Overshoot = %f percent \n",mp)
34 printf("Theta = %f rad \n",theta)
35 printf("Rise time = %f sec \n",tr)
36 printf("Peak Time = %f sec \n",tp)
37 printf("Settling time = %f sec \n",ts)

```

Scilab code Solution 7.7 To find Time response parameters for the given system

```

1 // OS : Windows 7
2 // Scilab : 5.4.1
3 // Toolboxes : Maxima 5.20.1 and ActivePerl 5.20.2
4
5 // Exercise 7 of Lab 7
6 // To find Time response parameters for the given
  system
7

```

```

8  clc
9  close
10
11 s=poly(0, 's');
12 tf=2025/(s^2+45*s+2025)
13
14 // To compare tf with  $W_n^2/(s^2+2*\zeta*W_n+W_n^2)$ 
15 y=denom(tf)
16 q=numer(tf)
17 z=coeff(y)
18 r=coeff(q)
19 wn=sqrt(r)
20
21 zeta=z(1,2)/(2*wn)
22 wd=(wn*sqrt(1-zeta^2))
23 mp=((%e^(-%pi*zeta/(sqrt(1-zeta^2)))))*100)
24 theta=atan(sqrt(1-zeta^2)/zeta);
25 tr=((%pi-theta)/wd)
26 tp=(%pi/wd)
27 ts=(4/(zeta*wn))
28
29 printf("Undamped natural frequency = %f rad/sec \n",
        wn)
30 printf("Damping ratio = %f \n",zeta)
31 printf("Damped frequency = %f rad/sec \n",wd)
32 printf("Maximum Peak Overshoot = %f percent \n",mp)
33 printf("Theta = %f rad \n",theta)
34 printf("Rise time = %f sec \n",tr)
35 printf("Peak Time = %f sec \n",tp)
36 printf("Settling time = %f sec \n",ts)

```

Scilab code Solution 7.8 To find Time response parameters for the given system

```

1 // OS : Windows 7
2 // Scilab : 5.4.1
3 // Toolboxes : Maxima 5.20.1 and ActivePerl 5.20.2
4
5 // Exercise 8 of Lab 7
6 // To find Time response parameters for the given
   system
7
8 clc
9 close
10
11 s=poly(0, 's');
12 g=6.25/(s^2+2*s)
13 tf=g/(1+g)
14
15 // To compare tf with  $Wn^2/(s^2+2*\zeta*Wn+Wn^2)$ 
16 y=denom(tf)
17 q=numer(tf)
18 z=coeff(y)
19 r=coeff(q)
20 wn=sqrt(r)
21
22 zeta=z(1,2)/(2*wn)
23 wd=(wn*sqrt(1-zeta^2))
24 mp=((%e^(-%pi*zeta/(sqrt(1-zeta^2))))*100)
25 theta=atan(sqrt(1-zeta^2)/zeta);
26 tr=((%pi-theta)/wd)
27 tp=(%pi/wd)
28 ts=(4/(zeta*wn))
29
30 printf("Undamped natural frequency = %f rad/sec \n",
   wn)
31 printf("Damping ratio = %f \n",zeta)
32 printf("Damped frequency = %f rad/sec \n",wd)
33 printf("Maximum Peak Overshoot = %f percent \n",mp)
34 printf("Theta = %f rad \n",theta)
35 printf("Rise time = %f sec \n",tr)
36 printf("Peak Time = %f sec \n",tp)

```

```
37 printf(" Settling time = %f sec \n",ts)
```

Scilab code Solution 7.9 To find Time response parameters for the given system

```
1 // OS : Windows 7
2 // Scilab : 5.4.1
3 // Toolboxes : Maxima 5.20.1 and ActivePerl 5.20.2
4
5 // Exercise 9 of Lab 7
6 // To find Time response parameters for the given
  system
7
8 clc
9 close
10
11 s=poly(0, 's');
12 tf=36481/(s^2+191*s+36481)
13
14 // To compare tf with  $W_n^2/(s^2+2*\zeta*W_n+W_n^2)$ 
15 y=denom(tf)
16 q=numer(tf)
17 z=coeff(y)
18 r=coeff(q)
19 wn=sqrt(r)
20
21 zeta=z(1,2)/(2*wn)
22 wd=(wn*sqrt(1-zeta^2))
23 mp=((%e^(-%pi*zeta/(sqrt(1-zeta^2))))*100)
24 theta=atan(sqrt(1-zeta^2)/zeta);
25 tr=((%pi-theta)/wd)
26 tp=(%pi/wd)
27 ts=(4/(zeta*wn))
```

```
28
29 printf("Undamped natural frequency = %f rad/sec \n",
        wn)
30 printf("Damping ratio = %f \n",zeta)
31 printf("Damped frequency = %f rad/sec \n",wd)
32 printf("Maximum Peak Overshoot = %f percent \n",mp)
33 printf("Theta = %f rad \n",theta)
34 printf("Rise time = %f sec \n",tr)
35 printf("Peak Time = %f sec \n",tp)
36 printf("Settling time = %f sec \n",ts)
```

Experiment: 8

Stability of Control Systems

Scilab code Solution 8.6 To find stability of given system using Routh Hurwitz criteria

```
1 // OS : Windows 7
2 // Scilab : 5.4.1
3 // Toolboxes : Maxima 5.20.1 and ActivePerl 5.20.2
4
5 // Exercise 6 of Lab 8
6 // To find stability of given system using Routh
   Hurwitz criterion
7
8 clc
9 close
10
11 s=%s;
12 p=s^3-4*s^2+s+6;
13 disp(p,"Given system function = ")
14 c=coeff(p)
15 l=length(c)
16 routh=routh_t(p) //This Function generates the Routh
   table
```

```

17 disp(routh,"Rouths table = ")
18 x=0;
19 for i=1:l
20 if (routh(i,1)<0)
21 x=x+1;
22 end
23 end
24 if(x>=1)
25     printf("From Rouths table , it is clear that the
            system is unstable.")
26 else
27     printf("From Rouths table , it is clear that the
            system is stable.")
28 end

```

Scilab code Solution 8.7 To find stability of given system using Routh Hurwitz criteria

```

1 // OS : Windows 7
2 // Scilab : 5.4.1
3 // Toolboxes : Maxima 5.20.1 and ActivePerl 5.20.2
4
5 // Exercise 7 of Lab 8
6 // To find stability of given system using Routh
   Hurwitz criterion
7
8 clc
9 close
10
11 s=%s;
12 p=2*s^4+s^3+3*s^2+5*s+10;
13 disp(p,"Given system function = ")
14 c=coeff(p)

```

```

15 l=length(c)
16 routh=routh_t(p) //This Function generates the Routh
    table
17 disp(routh,"Rouths table = ")
18 x=0;
19 for i=1:l
20 if (routh(i,1)<0)
21 x=x+1;
22 end
23 end
24 if(x>=1)
25     printf("From Rouths table , it is clear that the
        system is unstable.")
26 else
27     printf("From Rouths table , it is clear that the
        system is stable.")
28 end

```

Scilab code Solution 8.8 To find value of K for marginal stability of given system

```

1 // OS : Windows 7
2 // Scilab : 5.4.1
3 // Toolboxes : Maxima 5.20.1 and ActivePerl 5.20.2
4
5 // Exercise 8 of Lab 8
6 // To find value of K for marginal stability of
    given system
7
8 clc
9 close
10
11 s=%s

```

```

12 syms K
13 p=s^3+2*s^2+(1-K)*s+K
14 coef_a0 = coeffs(p, 's',0);
15 coef_a1 = coeffs(p, 's',1);
16 coef_a2 = coeffs(p, 's',2);
17 coef_a3 = coeffs(p, 's',3);
18
19 c=[coef_a0 coef_a1 coef_a2 coef_a3]
20
21 l=length(c);
22 routh=[c([4,2]);c([3,1])];
23 routh=[routh;-det(routh)/routh(2,1),0];
24 a=routh(2:3,1:2); //Getting the square sub block of
    routh matrix
25 routh=[routh;-det(a)/a(2,1),0]
26 disp(routh,"Rouths table = ")
27 routh(3,1)=0 //For marginal stability
28 sys=symlin('c',(1-s)/(s^3+2*s^2+s))
29 k=kpure(sys)
30 disp(k,"K(marginal)=")

```

Scilab code Solution 8.9 To find value of K for marginal stability of given system

```

1 // OS : Windows 7
2 // Scilab : 5.4.1
3 // Toolboxes : Maxima 5.20.1 and ActivePerl 5.20.2
4
5 // Exercise 9 of Lab 8
6 // To find value of K for marginal stability of
    given system
7
8 clc

```

```

9  close
10
11  s=%s
12  syms K
13  p=s^3+2.5*s^2+20*s+10*K
14  coef_a0 = coeffs(p, 's',0);
15  coef_a1 = coeffs(p, 's',1);
16  coef_a2 = coeffs(p, 's',2);
17  coef_a3 = coeffs(p, 's',3);
18
19  c=[coef_a0 coef_a1 coef_a2 coef_a3]
20
21  l=length(c);
22  routh=[c([4,2]);c([3,1])];
23  routh=[routh;-det(routh)/routh(2,1),0];
24  a=routh(2:3,1:2); //Getting the square sub block of
    routh matrix
25  routh=[routh;-det(a)/a(2,1),0]
26  disp(routh,"Rouths table = ")
27  routh(3,1)=0 //For marginal stability
28  sys=syslin('c',10/(s^3+2.5*s^2+20*s))
29  k=kpure(sys)
30  disp(k,"K(marginal)=")

```

Scilab code Solution 8.10 To find value of K for marginal stability of given system

```

1  // OS : Windows 7
2  // Scilab : 5.4.1
3  // Toolboxes : Maxima 5.20.1 and ActivePerl 5.20.2
4
5  // Exercise 10 of Lab 8
6  // To find value of K for marginal stability of

```

```

        given system
7
8  clc
9  close
10
11 s=%s
12 syms K
13 p=s^3+10*s^2+(21+K)*s+13*K
14 coef_a0 = coeffs(p, 's',0);
15 coef_a1 = coeffs(p, 's',1);
16 coef_a2 = coeffs(p, 's',2);
17 coef_a3 = coeffs(p, 's',3);
18
19 c=[coef_a0 coef_a1 coef_a2 coef_a3]
20
21 l=length(c);
22 routh=[c([4,2]);c([3,1])];
23 routh=[routh;-det(routh)/routh(2,1),0];
24 a=routh(2:3,1:2); //Getting the square sub block of
    routh matrix
25 routh=[routh;-det(a)/a(2,1),0]
26 disp(routh,"Rouths table = ")
27 routh(3,1)=0 //For marginal stability
28 sys=syslin('c',(s+13)/(s^3+10*s^2+21*s))
29 k=kpure(sys)
30 disp(k,"K(marginal)=")

```

Experiment: 9

Root Locus

Scilab code Solution 9.3 To sketch Root locus of given system

```
1 // OS : Windows 7
2 // Scilab : 5.4.1
3 // Toolboxes : Maxima 5.20.1 and ActivePerl 5.20.2
4
5 // Exercise 3 of Lab 9
6 // To sketch Root locus of given system
7
8 clc
9 close
10 clf
11
12 s=%s
13 h=syslin('c',1/(s^3))
14 evans(h,100)
15 sgrid()
```

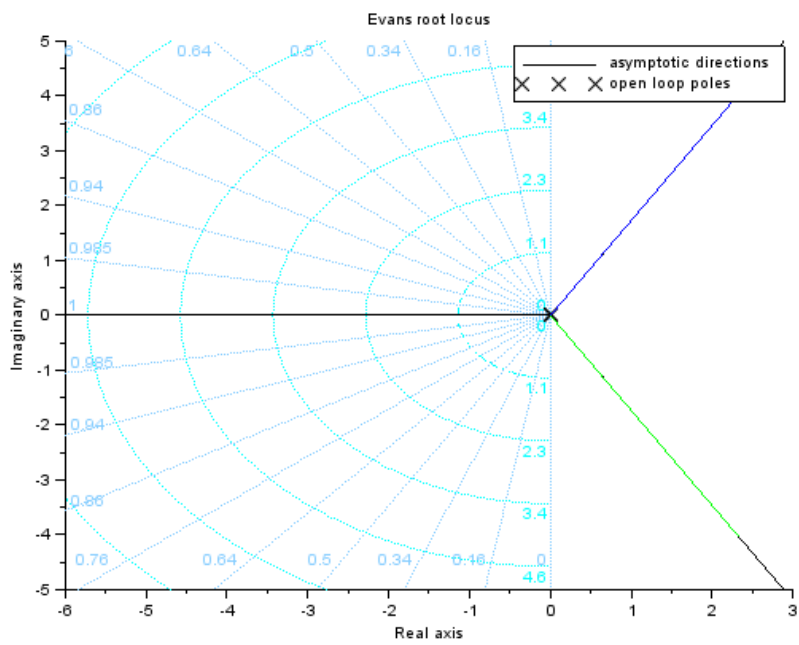

Figure 9.1: To sketch Root locus of given system

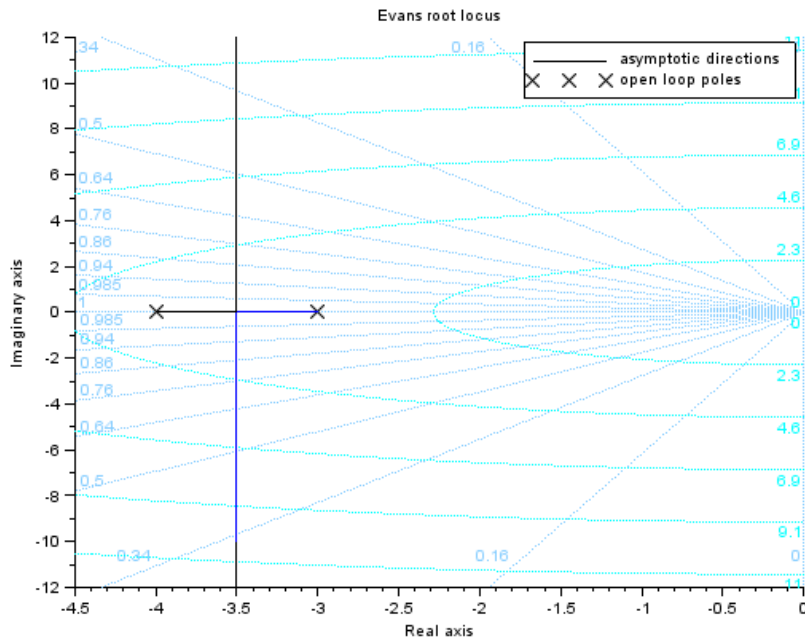

Figure 9.2: To sketch Root locus of given system

Scilab code Solution 9.4 To sketch Root locus of given system

```
1 // OS : Windows 7
2 // Scilab : 5.4.1
3 // Toolboxes : Maxima 5.20.1 and ActivePerl 5.20.2
4
5 // Exercise 4 of Lab 9
6 // To sketch Root locus of given system
7
8 clc
9 close
10 clf
11
12 s=%s
13 h=syslin('c',1/((s+4)*(s+3)))
14 evans(h,100)
15 sgrid()
```

Scilab code Solution 9.5 To sketch Root locus of given system

```
1 // OS : Windows 7
2 // Scilab : 5.4.1
3 // Toolboxes : Maxima 5.20.1 and ActivePerl 5.20.2
4
5 // Exercise 5 of Lab 9
6 // To sketch Root locus of given system
7
8 clc
9 close
10 clf
```

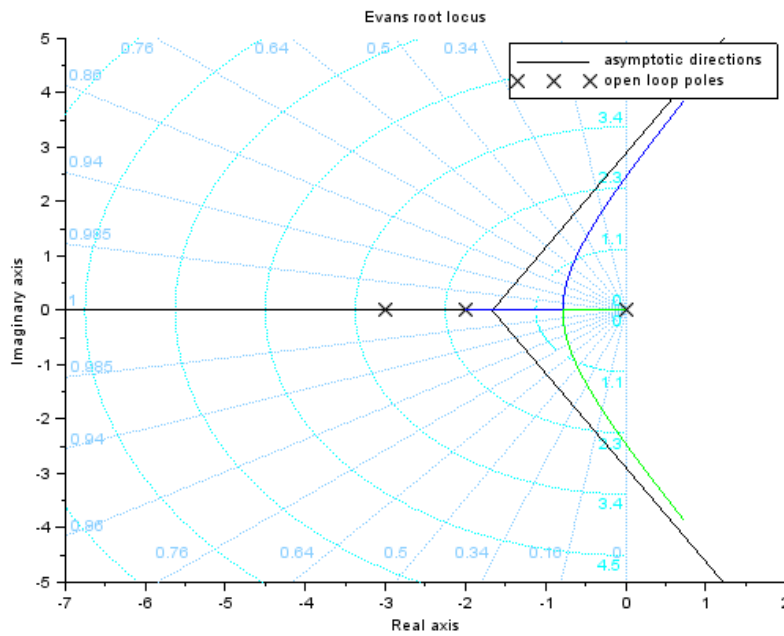

Figure 9.3: To sketch Root locus of given system

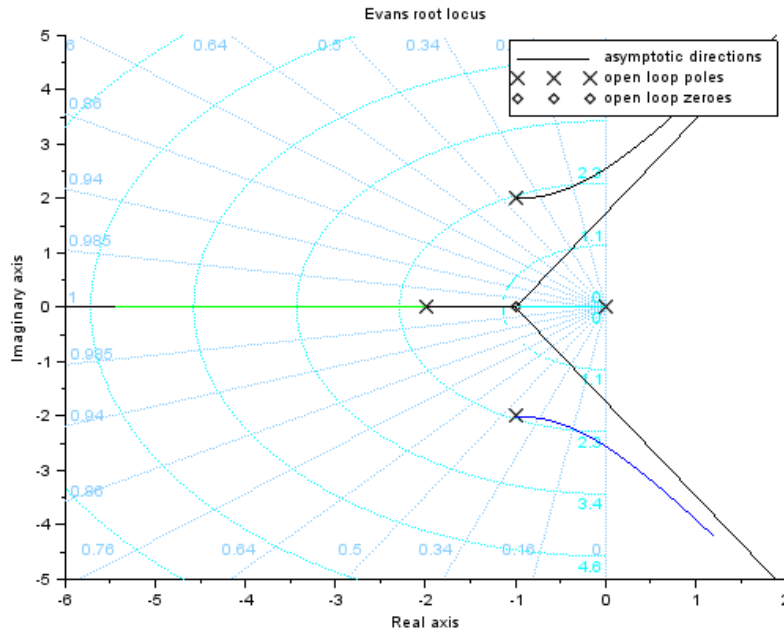

Figure 9.4: To sketch Root locus of given system

```

11
12 s=%s
13 h=syslin('c',1/((s)*(s+2)*(s+3)))
14 evans(h,100)
15 sgrid()

```

Scilab code Solution 9.6 To sketch Root locus of given system

```

1 // OS : Windows 7
2 // Scilab : 5.4.1
3 // Toolboxes : Maxima 5.20.1 and ActivePerl 5.20.2

```

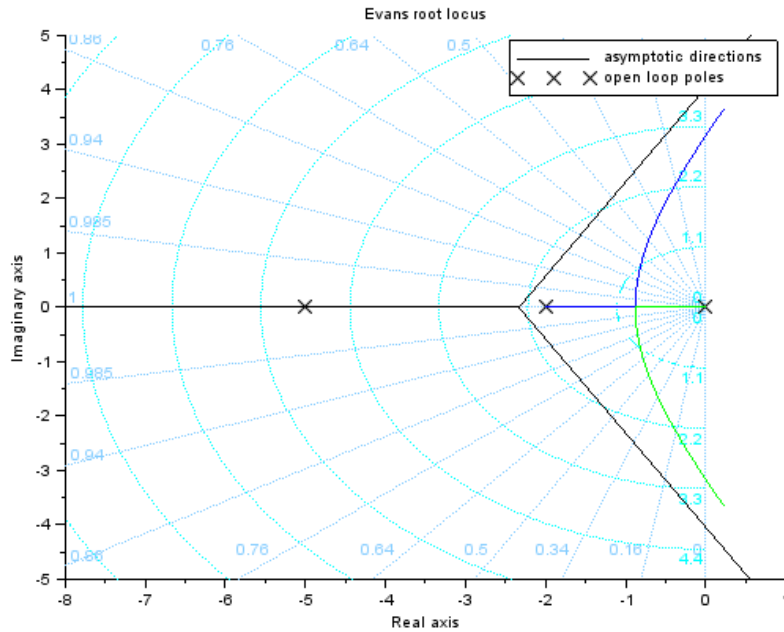

Figure 9.5: To sketch Root locus of given system

```

4
5 // Exercise 6 of Lab 9
6 // To sketch Root locus of given system
7
8 clc
9 close
10 clf
11
12 s=%s
13 h=syslin('c',(s+1)/(s*(s+2)*(s^2+2*s+5)))
14 evans(h,100)
15 sgrid()

```

Scilab code Solution 9.7 To sketch Root locus of given system

```
1 // OS : Windows 7
2 // Scilab : 5.4.1
3 // Toolboxes : Maxima 5.20.1 and ActivePerl 5.20.2
4
5 // Exercise 7 of Lab 9
6 // To sketch Root locus of given system
7
8 clc
9 close
10 clf
11
12 s=%s
13 h=syslin('c',1/(s*(s+2)*(s+5)))
14 evans(h,100)
15 sgrid()
```

Scilab code Solution 9.8 To sketch Root locus of given system

```
1 // OS : Windows 7
2 // Scilab : 5.4.1
3 // Toolboxes : Maxima 5.20.1 and ActivePerl 5.20.2
4
5 // Exercise 8 of Lab 9
6 // To sketch Root locus of given system
7
8 clc
9 close
10 clf
```

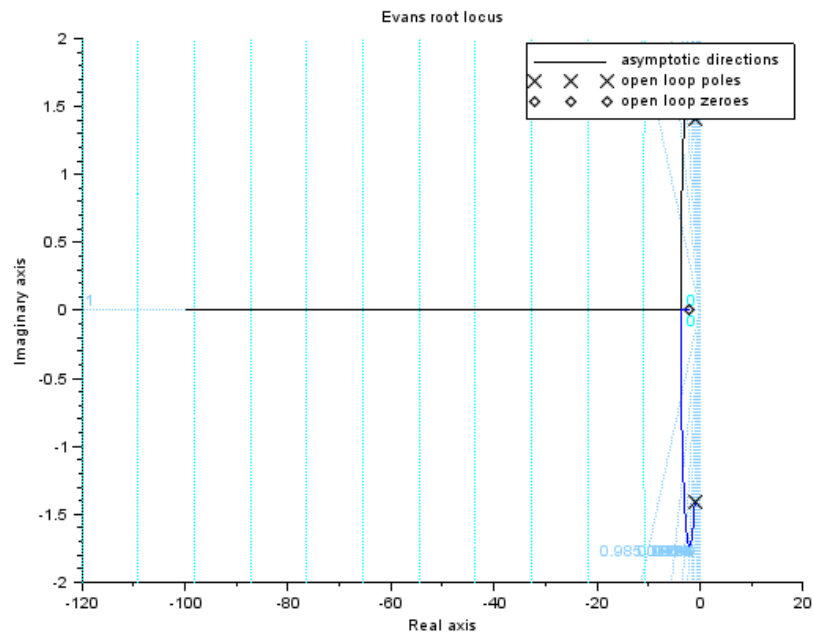

Figure 9.6: To sketch Root locus of given system

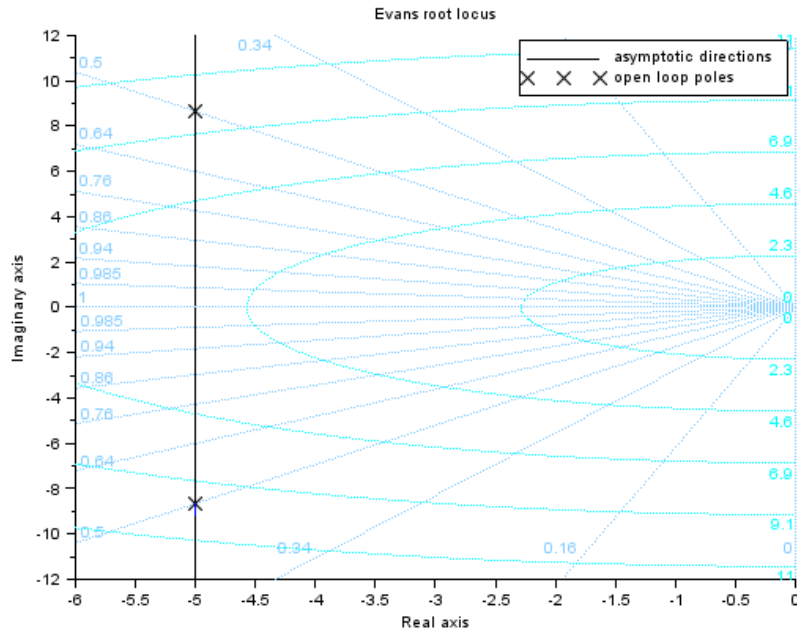

Figure 9.7: To sketch Root locus of given system

```

11
12 s=%s
13 h=syslin('c',(s+2)/(s^2+2*s+3))
14 evans(h,100)
15 sgrid()

```

Scilab code Solution 9.9 To sketch Root locus of given system

```

1 // OS : Windows 7
2 // Scilab : 5.4.1
3 // Toolboxes : Maxima 5.20.1 and ActivePerl 5.20.2

```

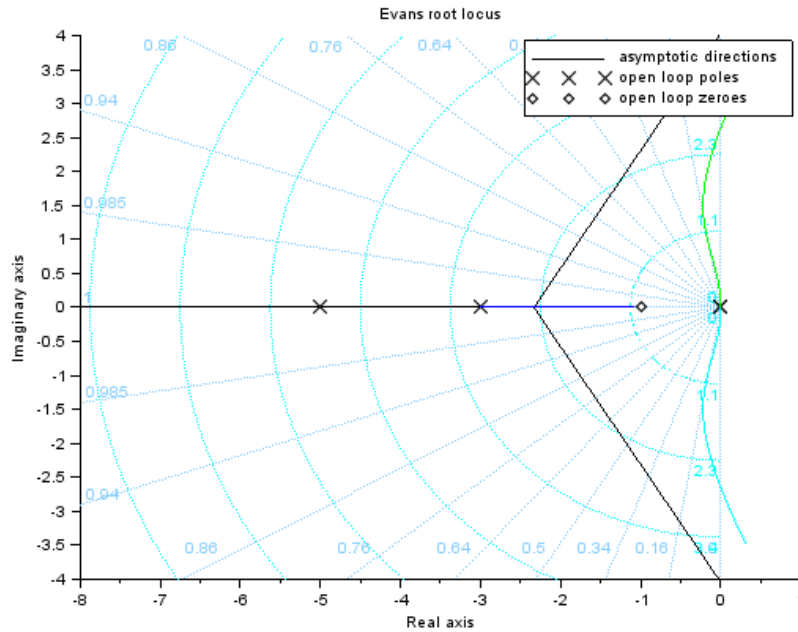

Figure 9.8: To sketch Root locus of given system

```

4
5 // Exercise 9 of Lab 9
6 // To sketch Root locus of given system
7
8 clc
9 close
10 clf
11
12 s=%s
13 h=syslin('c',1/(s^2+10*s+100))
14 evans(h,100)
15 sgrid()

```

Scilab code Solution 9.10 To sketch Root locus of given system

```
1 // OS : Windows 7
2 // Scilab : 5.4.1
3 // Toolboxes : Maxima 5.20.1 and ActivePerl 5.20.2
4
5 // Exercise 10 of Lab 9
6 // To sketch Root locus of given system
7
8 clc
9 close
10 clf
11
12 s=%s
13 h=syslin('c', (s+1)/(s^2*(s+3)*(s+5)))
14 evans(h,100)
15 sgrid()
```

Scilab code Solution 9.11 To sketch Root locus of given system

```
1 // OS : Windows 7
2 // Scilab : 5.4.1
3 // Toolboxes : Maxima 5.20.1 and ActivePerl 5.20.2
4
5 // Exercise 11 of Lab 9
6 // To sketch Root locus of given system
7
8 clc
9 close
10 clf
```

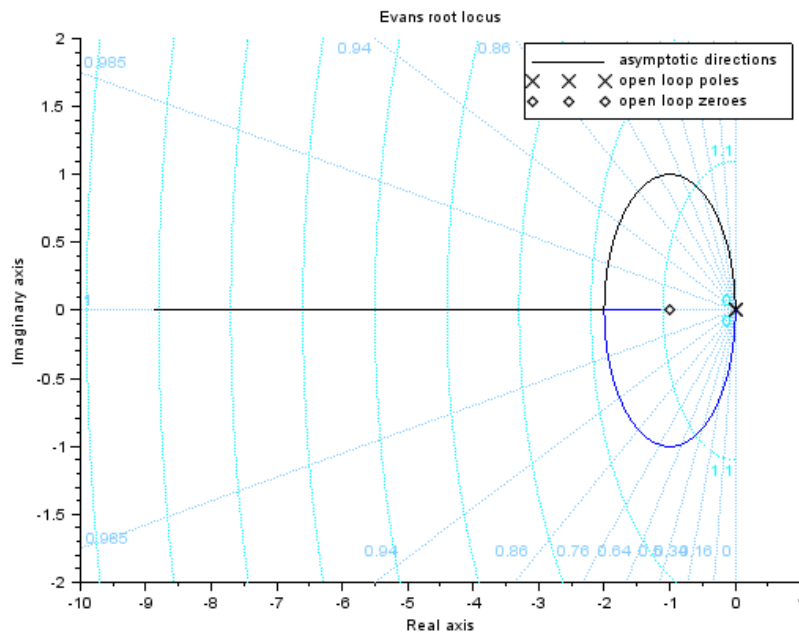

Figure 9.9: To sketch Root locus of given system

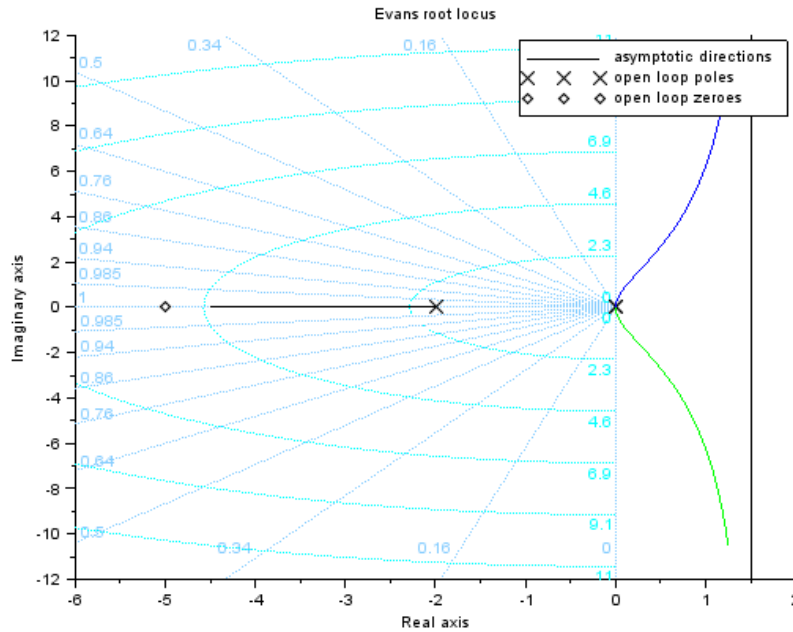

Figure 9.10: To sketch Root locus of given system

```

11
12 s=%s
13 h=syslin('c',(s+1)/(s^2))
14 evans(h,10)
15 sgrid()

```

Scilab code Solution 9.12 To sketch Root locus of given system

```

1 // OS : Windows 7
2 // Scilab : 5.4.1
3 // Toolboxes : Maxima 5.20.1 and ActivePerl 5.20.2

```

```
4
5 // Exercise 12 of Lab 9
6 // To sketch Root locus of given system
7
8 clc
9 close
10 clf
11
12 s=%s
13 h=syslin('c',(s+5)/(s^2*(s+2)))
14 evans(h,100)
15 sgrid()
```

Experiment: 10

Frequency Response Analysis

Scilab code Solution 10.5 To find Frequency domain specifications for the given system

```
1 // OS : Windows 7
2 // Scilab : 5.4.1
3 // Toolboxes : Maxima 5.20.1 and ActivePerl 5.20.2
4
5 // Exercise 5 of Lab 10
6 // To find Frequency domain specifications for the
   given system
7
8 clc
9 close
10
11 s=poly(0, 's');
12 g1=3
13 g2=12/(s^2+3*s)
14 g=g1*g2
15 tf=g/(1+g)
16
17 // To compare tf with  $\frac{Wn^2}{(s^2+2*\zeta*Wn+Wn^2)}$ 
```

```

18 y=denom(tf)
19 q=numer(tf)
20 z=coeff(y)
21 r=coeff(q)
22 wn=sqrt(r)
23 zeta=z(1,2)/(2*wn)
24
25 mr=1/(2*zeta*sqrt(1-zeta^2))
26 phi_r=-atan(sqrt(1-2*zeta^2)/zeta)
27 wr=wn*sqrt(1-2*zeta^2)
28 BW=wn*sqrt(1-2*zeta^2+sqrt(2-4*zeta^2+4*zeta^4))
29
30 printf("Resonant Peak = %f \n", mr)
31 printf("Phase at resonant peak = %f rad \n", phi_r)
32 printf("Resonant Frequency = %f rad/sec \n", wr)
33 printf("Bandwidth = %f rad/sec \n", BW)

```

Scilab code Solution 10.6 To find Frequency domain specifications for the given system

```

1 // OS : Windows 7
2 // Scilab : 5.4.1
3 // Toolboxes : Maxima 5.20.1 and ActivePerl 5.20.2
4
5 // Exercise 6 of Lab 10
6 // To find Frequency domain specifications for the
   given system
7
8 clc
9 close
10
11 s=poly(0, 's');
12 tf=5/(s^2+2*s+5)

```

```

13
14 // To compare tf with  $W_n^2/(s^2+2*\zeta*W_n+W_n^2)$ 
15 y=denom(tf)
16 q=numer(tf)
17 z=coeff(y)
18 r=coeff(q)
19 wn=sqrt(r)
20 zeta=z(1,2)/(2*wn)
21
22 mr=1/(2*zeta*sqrt(1-zeta^2))
23 phi_r=-atan(sqrt(1-2*zeta^2)/zeta)
24 wr=wn*sqrt(1-2*zeta^2)
25 BW=wn*sqrt(1-2*zeta^2+sqrt(2-4*zeta^2+4*zeta^4))
26
27 printf("Resonant Peak = %f \n", mr)
28 printf("Phase at resonant peak = %f rad \n",phi_r)
29 printf("Resonant Frequency = %f rad/sec \n",wr)
30 printf("Bandwidth = %f rad/sec \n",BW)

```

Scilab code Solution 10.7 To find Frequency domain specifications for the given system

```

1 // OS : Windows 7
2 // Scilab : 5.4.1
3 // Toolboxes : Maxima 5.20.1 and ActivePerl 5.20.2
4
5 // Exercise 7 of Lab 10
6 // To find Frequency domain specifications for the
   given system
7
8 clc
9 close
10

```

```

11 s=poly(0, 's');
12 g=100/(s*(s+8))
13 tf=g/(1+g)
14
15 // To compare tf with  $W_n^2/(s^2+2*\zeta*W_n+W_n^2)$ 
16 y=denom(tf)
17 q=numer(tf)
18 z=coeff(y)
19 r=coeff(q)
20 wn=sqrt(r)
21 zeta=z(1,2)/(2*wn)
22
23 mr=1/(2*zeta*sqrt(1-zeta^2))
24 phi_r=-atan(sqrt(1-2*zeta^2)/zeta)
25 wr=wn*sqrt(1-2*zeta^2)
26 BW=wn*sqrt(1-2*zeta^2+sqrt(2-4*zeta^2+4*zeta^4))
27
28 printf("Resonant Peak = %f \n", mr)
29 printf("Phase at resonant peak = %f rad \n", phi_r)
30 printf("Resonant Frequency = %f rad/sec \n", wr)
31 printf("Bandwidth = %f rad/sec \n", BW)

```

Scilab code Solution 10.8 To find Frequency domain specifications for the given system

```

1 // OS : Windows 7
2 // Scilab : 5.4.1
3 // Toolboxes : Maxima 5.20.1 and ActivePerl 5.20.2
4
5 // Exercise 8 of Lab 10
6 // To find Frequency domain specifications for the
  given system
7

```

```

8  clc
9  close
10
11 s=poly(0, 's');
12 tf=2006/(s^2+10*s+2006)
13
14 // To compare tf with  $W_n^2/(s^2+2*\zeta*W_n+W_n^2)$ 
15 y=denom(tf)
16 q=numer(tf)
17 z=coeff(y)
18 r=coeff(q)
19 wn=sqrt(r)
20 zeta=z(1,2)/(2*wn)
21
22 mr=1/(2*zeta*sqrt(1-zeta^2))
23 phi_r=-atan(sqrt(1-2*zeta^2)/zeta)
24 wr=wn*sqrt(1-2*zeta^2)
25 BW=wn*sqrt(1-2*zeta^2+sqrt(2-4*zeta^2+4*zeta^4))
26
27 printf("Resonant Peak = %f \n", mr)
28 printf("Phase at resonant peak = %f rad \n", phi_r)
29 printf("Resonant Frequency = %f rad/sec \n", wr)
30 printf("Bandwidth = %f rad/sec \n", BW)

```

Experiment: 11

Polar Plots

Scilab code Solution 11.3 To obtain Polar plot of given system

```
1 // OS : Windows 7
2 // Scilab : 5.4.1
3 // Toolboxes : Maxima 5.20.1 and ActivePerl 5.20.2
4
5 // Exercise 3 of Lab 11
6 // To sketch Polar plot of given system
7
8 clc
9 close
10 clf
11
12 s=0:.1:2*%pi;
13 h=10/(1+5*s);
14 polarplot(s,h);
```

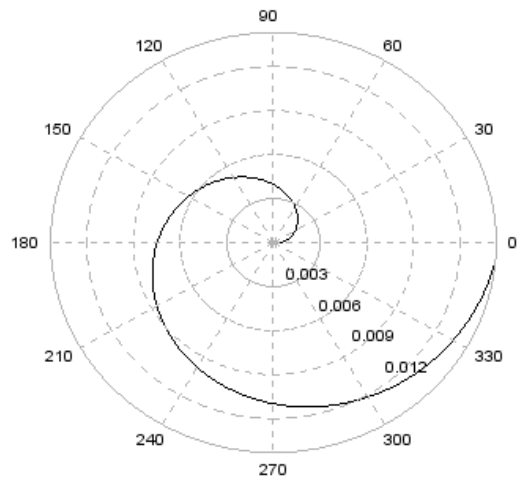

Figure 11.1: To obtain Polar plot of given system

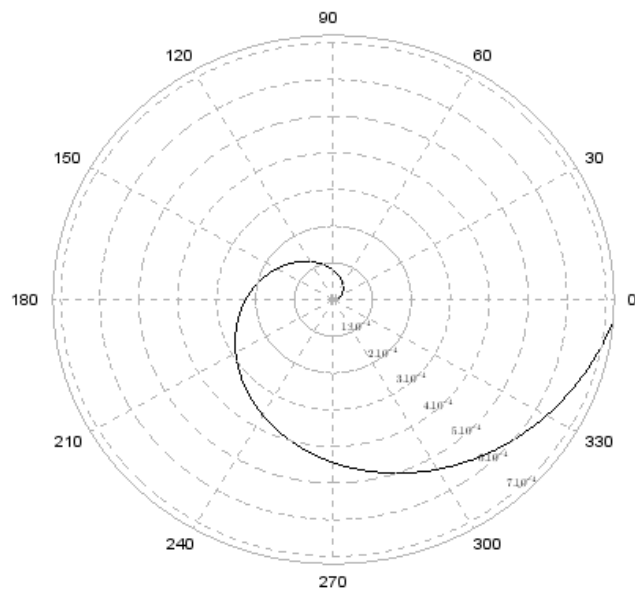

Figure 11.2: To obtain Polar plot of given system

Scilab code Solution 11.4 To obtain Polar plot of given system

```
1 // OS : Windows 7
2 // Scilab : 5.4.1
3 // Toolboxes : Maxima 5.20.1 and ActivePerl 5.20.2
4
5 // Exercise 4 of Lab 11
6 // To sketch Polar plot of given system
7
8 clc
9 close
10 clf
11
12 s=0:.1:2*%pi;
13 h=1/(1+3*s+2*s^2)
14 polarplot(s,h);
```

Scilab code Solution 11.5 To obtain Polar plot of given system

```
1 // OS : Windows 7
2 // Scilab : 5.4.1
3 // Toolboxes : Maxima 5.20.1 and ActivePerl 5.20.2
4
5 // Exercise 5 of Lab 11
6 // To sketch Polar plot of given system
7
8 clc
9 close
10 clf
11
12 s=0:.1:2*%pi*4;
13 h=1/(s+3*s^2+2*s^3)
14 polarplot(s,h);
```

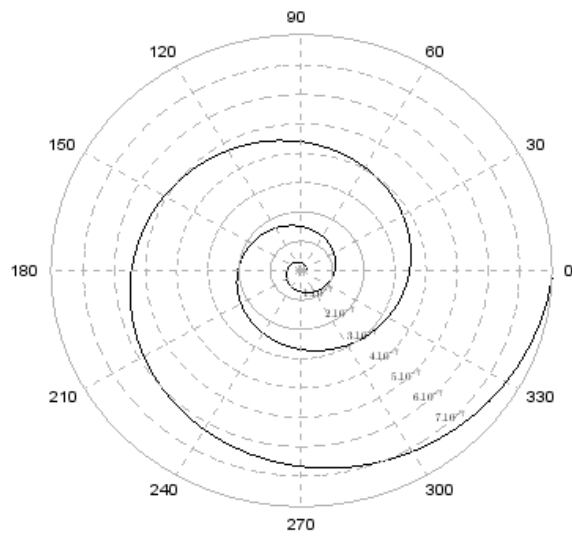

Figure 11.3: To obtain Polar plot of given system

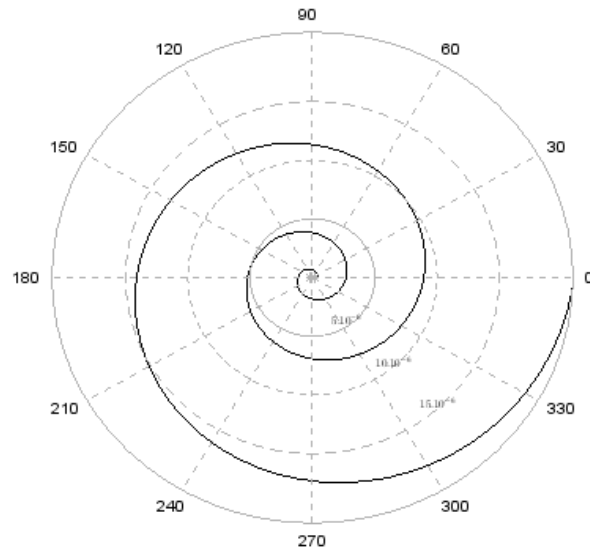

Figure 11.4: To obtain Polar plot of given system

Scilab code Solution 11.6 To obtain Polar plot of given system

```

1 // OS : Windows 7
2 // Scilab : 5.4.1
3 // Toolboxes : Maxima 5.20.1 and ActivePerl 5.20.2
4
5 // Exercise 6 of Lab 11
6 // To sketch Polar plot of given system
7
8 clc

```

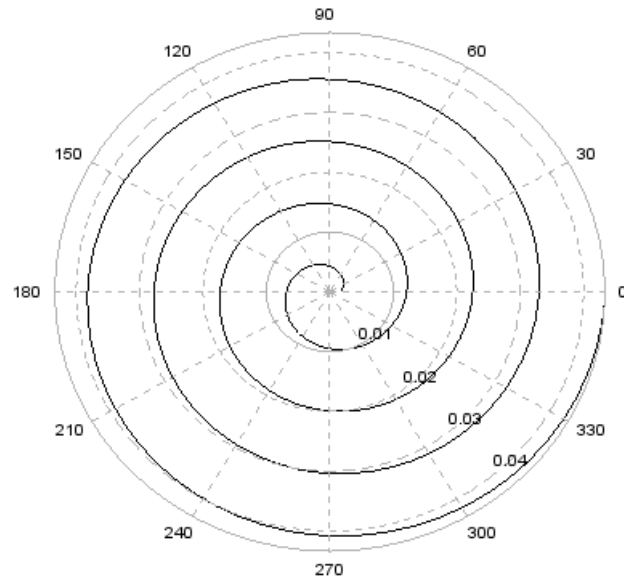

Figure 11.5: To obtain Polar plot of given system

```

9  close
10 clf
11
12 s=0:.1:2*%pi*4;
13 h=100/(s+6*s^2+8*s^3)
14 polarplot(s,h);

```

Scilab code Solution 11.7 To obtain Polar plot of given system

```

1
2

```

```

3
4
5
6 // OS : Windows 7
7 // Scilab : 5.4.1
8 // Toolboxes : Maxima 5.20.1 and ActivePerl 5.20.2
9
10 // Exercise 7 of Lab 11
11 // To sketch Polar plot of given system
12
13 clc
14 close
15 clf
16
17 s=0:.1:2*%pi*4;
18 h=99/(s+1)
19 polarplot(s,h);

```

Scilab code Solution 11.8 To obtain Polar plot of given system

```

1 // OS : Windows 7
2 // Scilab : 5.4.1
3 // Toolboxes : Maxima 5.20.1 and ActivePerl 5.20.2
4
5 // Exercise 8 of Lab 11
6 // To sketch Polar plot of given system
7
8 clc
9 close
10 clf
11
12 s=0:.1:2*%pi*4;
13 h=(200/(s+20))

```

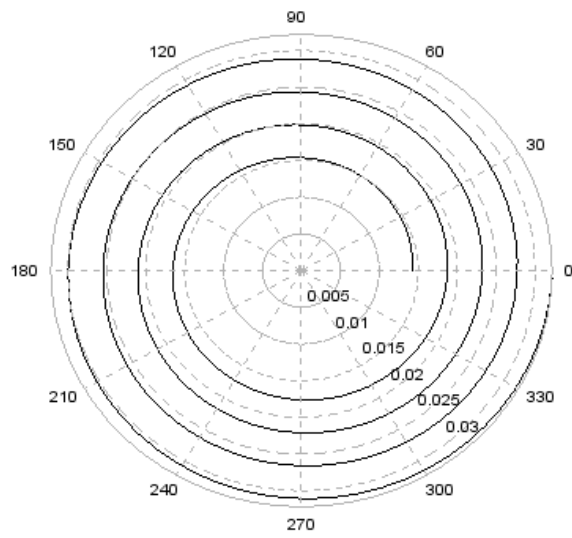

Figure 11.6: To obtain Polar plot of given system

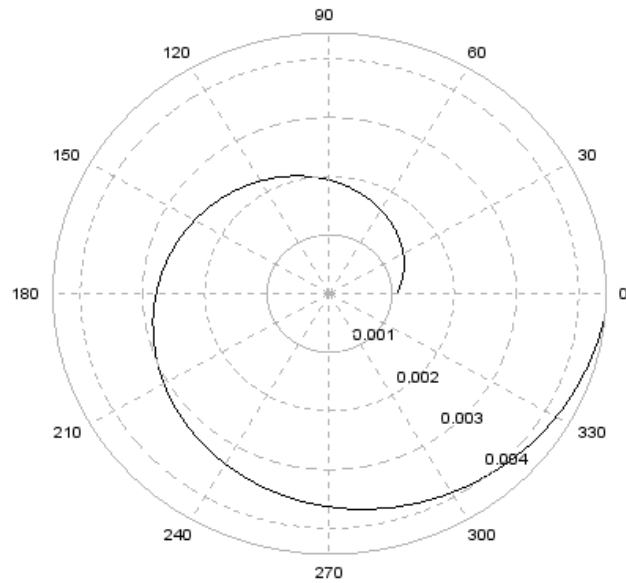

Figure 11.7: To obtain Polar plot of given system

14 `polarplot(s,h);`

Scilab code Solution 11.9 To obtain Polar plot of given system

```

1 // OS : Windows 7
2 // Scilab : 5.4.1
3 // Toolboxes : Maxima 5.20.1 and ActivePerl 5.20.2
4
5 // Exercise 9 of Lab 11
6 // To sketch Polar plot of given system
7

```

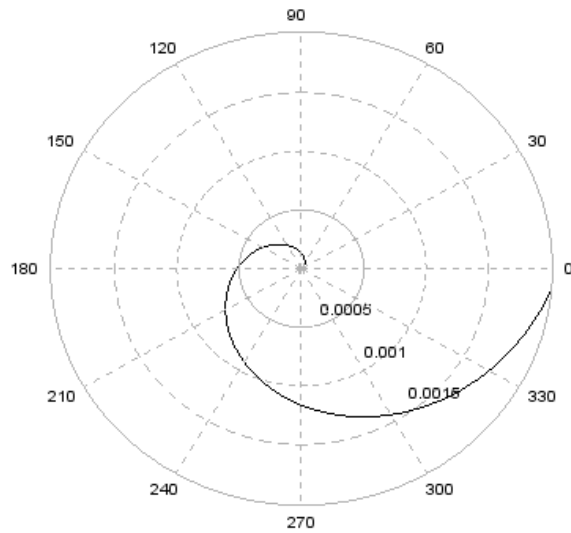

Figure 11.8: To obtain Polar plot of given system

```

8  clc
9  close
10 clf
11
12 s=0:.1:2*%pi;
13 h=(1/(s+2))
14 polarplot(s,h);

```

Scilab code Solution 11.10 To obtain Polar plot of given system

```

1  // OS : Windows 7

```

```

2 // Scilab : 5.4.1
3 // Toolboxes : Maxima 5.20.1 and ActivePerl 5.20.2
4
5 // Exercise 10 of Lab 11
6 // To sketch Polar plot of given system
7
8 clc
9 close
10 clf
11
12 s=0:.1:2*pi;
13 h=(1/(s^2))
14 polarplot(s,h);

```

Scilab code Solution 11.11 To obtain Polar plot of given system

```

1 // OS : Windows 7
2 // Scilab : 5.4.1
3 // Toolboxes : Maxima 5.20.1 and ActivePerl 5.20.2
4
5 // Exercise 11 of Lab 11
6 // To sketch Polar plot of given system
7
8 clc
9 close
10 clf
11
12 s=0:.1:2*pi;
13 h=(1/(s^3))
14 polarplot(s,h);

```

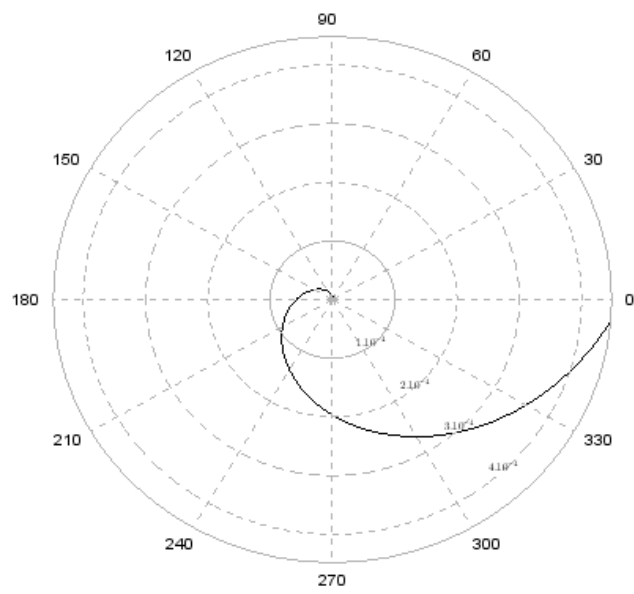

Figure 11.9: To obtain Polar plot of given system

Experiment: 12

Nyquist Plots

Scilab code Solution 12.3 To obtain Nyquist plot of given system

```
1 // OS : Windows 7
2 // Scilab : 5.4.1
3 // Toolboxes : Maxima 5.20.1 and ActivePerl 5.20.2
4
5 // Exercise 3 of Lab 12
6 // To obtain Nyquist plot for given system
7
8 clc
9 close
10
11 s=poly(0, 's')
12 h=syslin('c', (s*4+1)/((s^2*(s+1)*(2*s+1)))
13 nyquist(h);
```

Scilab code Solution 12.4 To obtain Nyquist plot of given system

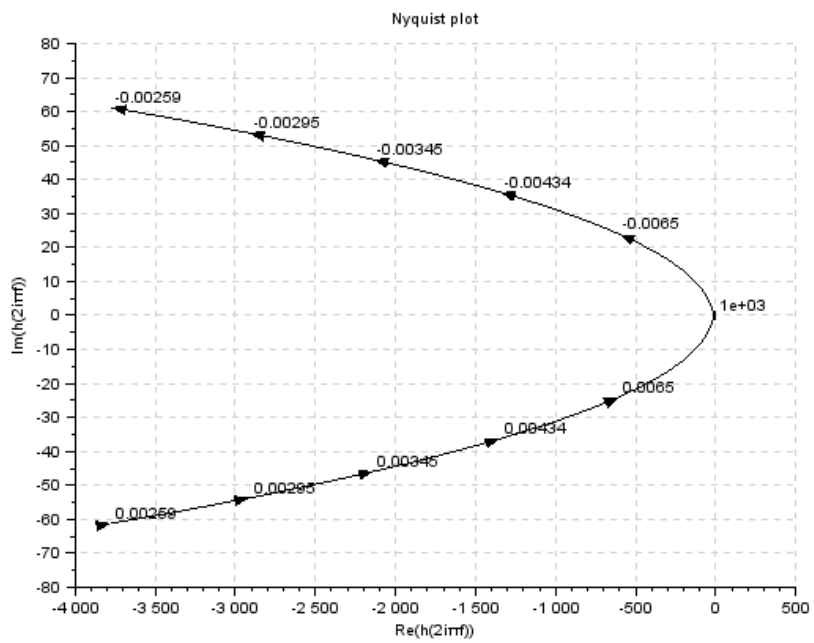

Figure 12.1: To obtain Nyquist plot of given system

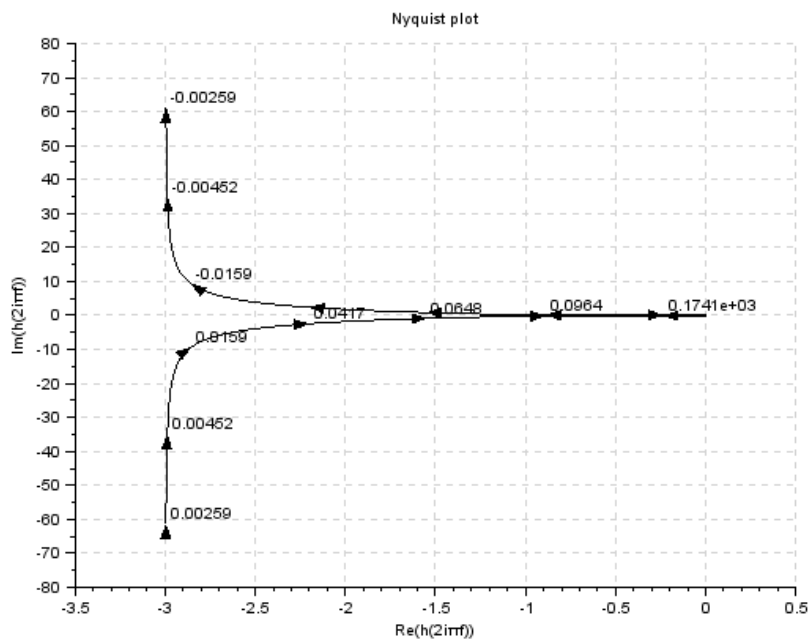

Figure 12.2: To obtain Nyquist plot of given system

```

1 // OS : Windows 7
2 // Scilab : 5.4.1
3 // Toolboxes : Maxima 5.20.1 and ActivePerl 5.20.2
4
5 // Exercise 4 of Lab 12
6 // To obtain Nyquist plot for given system
7
8 clc
9 close
10
11 s=poly(0, 's')
12 h=syslin('c', (1)/((s*(s+1)*(2*s+1))))
13 nyquist(h);

```

Scilab code Solution 12.5 To obtain Nyquist plot of given system

```

1 // OS : Windows 7
2 // Scilab : 5.4.1
3 // Toolboxes : Maxima 5.20.1 and ActivePerl 5.20.2
4
5 // Exercise 5 of Lab 12
6 // To obtain Nyquist plot for given system
7
8 clc
9 close
10
11 s=poly(0, 's')
12 h=syslin('c', (s+2)/((s+1)*(s-1)))
13 nyquist(h);

```

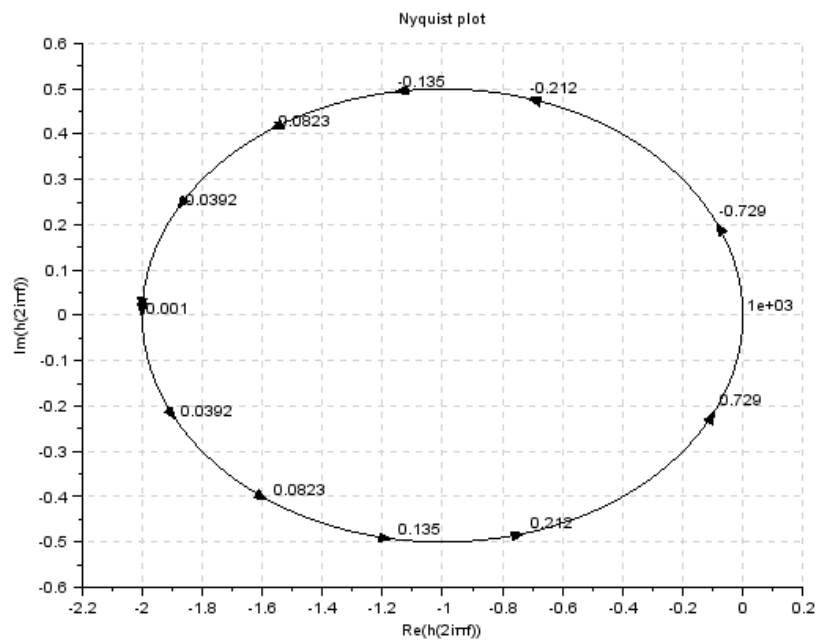

Figure 12.3: To obtain Nyquist plot of given system

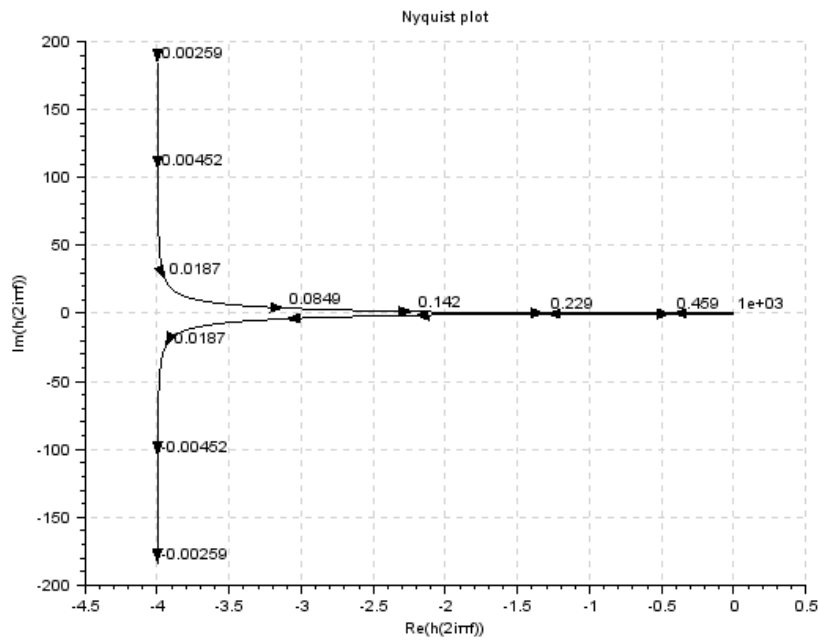

Figure 12.4: To obtain Nyquist plot of given system

Scilab code Solution 12.6 To obtain Nyquist plot of given system

```
1 // OS : Windows 7
2 // Scilab : 5.4.1
3 // Toolboxes : Maxima 5.20.1 and ActivePerl 5.20.2
4
5 // Exercise 6 of Lab 12
6 // To obtain Nyquist plot for given system
7
8 clc
9 close
10
11 s=poly(0, 's')
12 h=syslin('c', (s+3)/((s*(s-1))))
13 nyquist(h);
```

Scilab code Solution 12.7 To obtain Nyquist plot of given system

```
1
2
3
4
5
6 // OS : Windows 7
7 // Scilab : 5.4.1
8 // Toolboxes : Maxima 5.20.1 and ActivePerl 5.20.2
9
10 // Exercise 7 of Lab 12
11 // To obtain Nyquist plot for given system
12
```

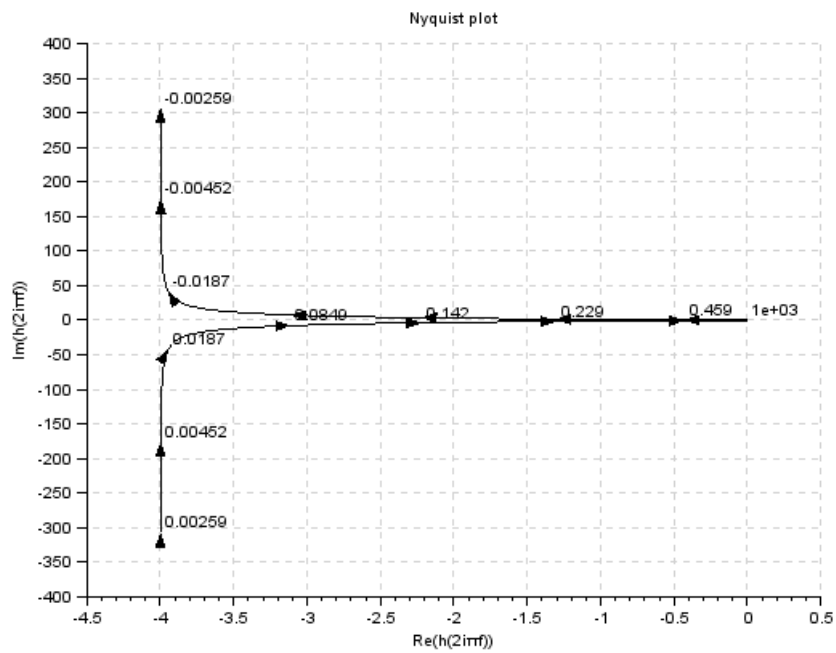

Figure 12.5: To obtain Nyquist plot of given system

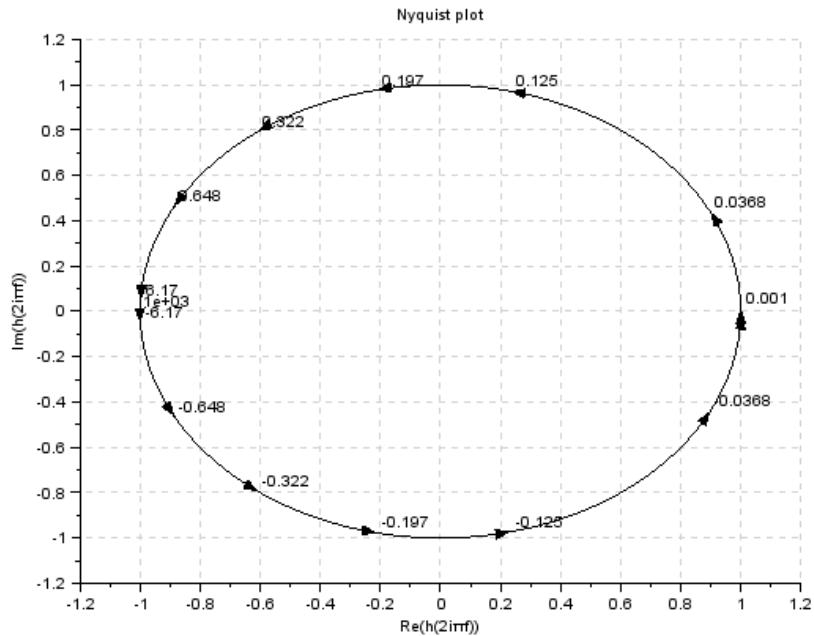

Figure 12.6: To obtain Nyquist plot of given system

```

13 clc
14 close
15
16 s=poly(0, 's')
17 h=syslin('c', (s+5)/((s*(s+1))))
18 nyquist(h);

```

Scilab code Solution 12.8 To obtain Nyquist plot of given system

```

1 // OS : Windows 7
2 // Scilab : 5.4.1

```

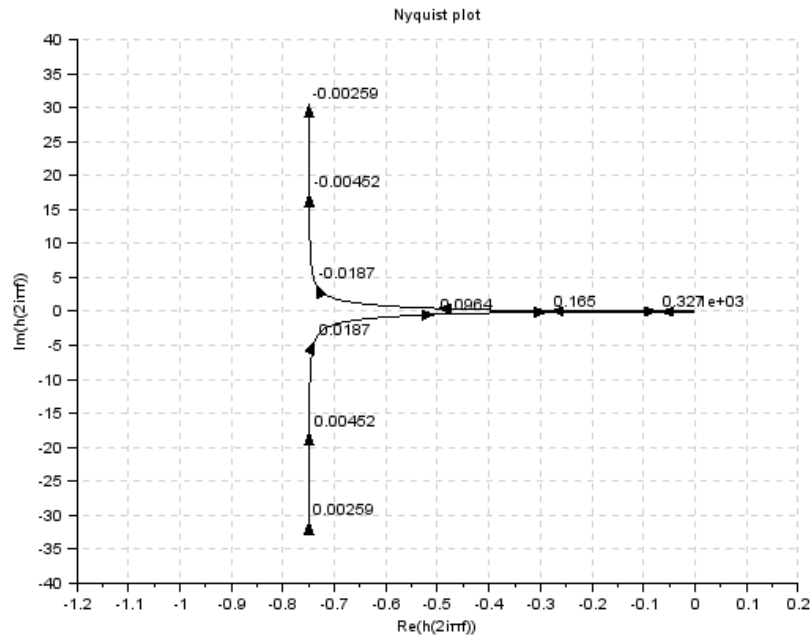

Figure 12.7: To obtain Nyquist plot of given system

```

3 // Toolboxes : Maxima 5.20.1 and ActivePerl 5.20.2
4
5 // Exercise 8 of Lab 12
6 // To obtain Nyquist plot for given system
7
8 clc
9 close
10
11 s=poly(0, 's')
12 h=syslin('c', (1+s)/(1-s))
13 nyquist(h)

```

Scilab code Solution 12.9 To obtain Nyquist plot of given system

```
1 // OS : Windows 7
2 // Scilab : 5.4.1
3 // Toolboxes : Maxima 5.20.1 and ActivePerl 5.20.2
4
5 // Exercise 9 of Lab 12
6 // To obtain Nyquist plot for given system
7
8 clc
9 close
10
11 s=poly(0, 's')
12 h=syslin('c', 1/((s*(s+1)*(s+2))))
13 nyquist(h);
```

Scilab code Solution 12.10 To obtain Nyquist plot of given system

```
1 // OS : Windows 7
2 // Scilab : 5.4.1
3 // Toolboxes : Maxima 5.20.1 and ActivePerl 5.20.2
4
5 // Exercise 10 of Lab 12
6 // To obtain Nyquist plot for given system
7
8 clc
9 close
10
11 s=poly(0, 's')
12 h=syslin('c', (s^2+2*s+3)/(s+2))
13 nyquist(h, 0.000001, 1)
```

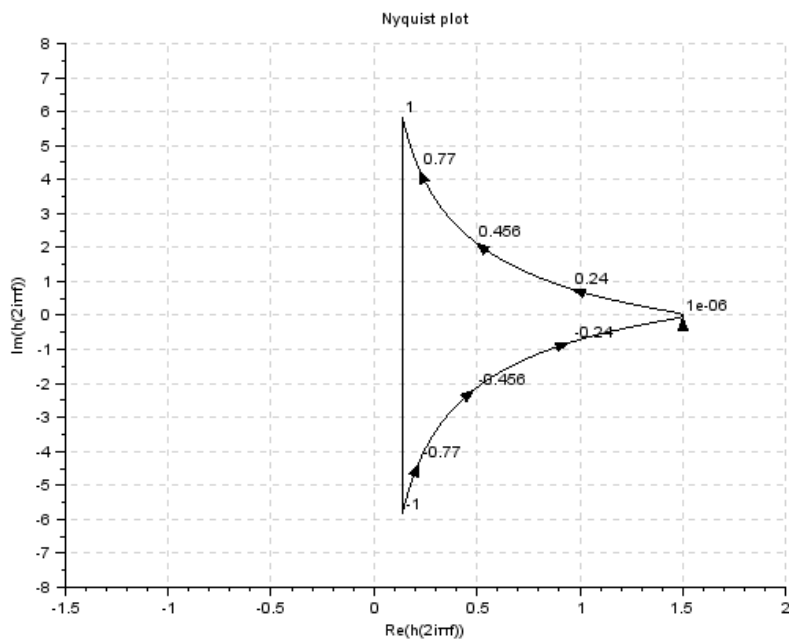

Figure 12.8: To obtain Nyquist plot of given system

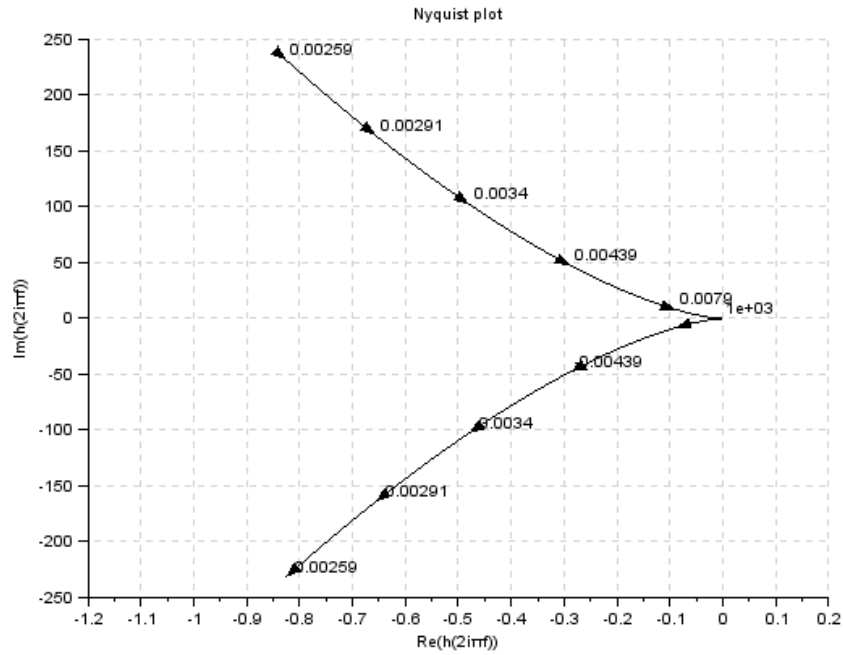

Figure 12.9: To obtain Nyquist plot of given system

Scilab code Solution 12.11 To obtain Nyquist plot of given system

```

1
2
3
4
5
6 // OS : Windows 7
7 // Scilab : 5.4.1
8 // Toolboxes : Maxima 5.20.1 and ActivePerl 5.20.2

```

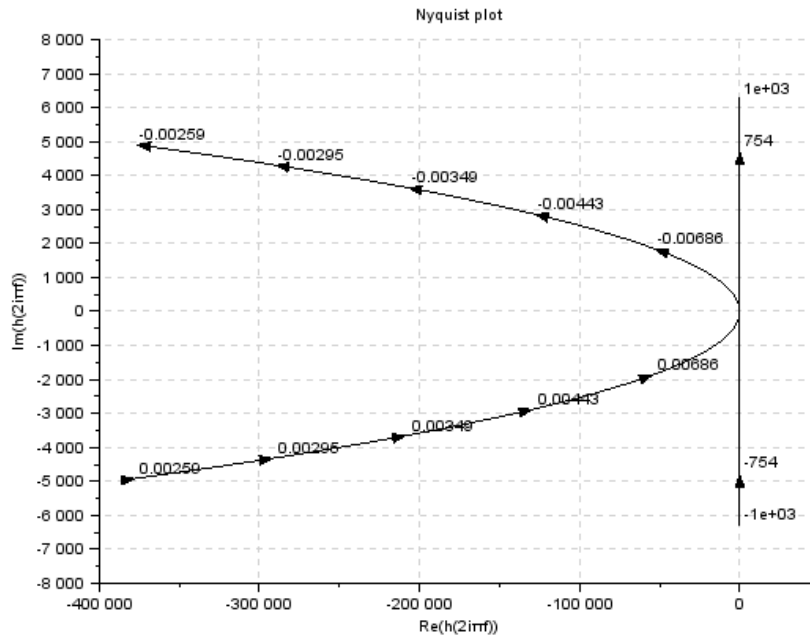

Figure 12.10: To obtain Nyquist plot of given system

```

9
10 // Exercise 11 of Lab 12
11 // To obtain Nyquist plot for given system
12
13 clc
14 close
15
16 s=poly(0, 's')
17 h=syslin('c', (5+s)*(s+40)/((s^3)*(s+200)*(s+1000)))
18 nyquist(h)

```

Scilab code Solution 12.12 To obtain Nyquist plot of given system

```
1 // OS : Windows 7
2 // Scilab : 5.4.1
3 // Toolboxes : Maxima 5.20.1 and ActivePerl 5.20.2
4
5 // Exercise 12 of Lab 12
6 // To obtain Nyquist plot for given system
7
8 clc
9 close
10
11 s=poly(0, 's')
12 h=syslin('c', (5+s)/(s^2)*(s+2)*(s+10))
13 nyquist(h)
```

Experiment: 13

Bode Plots

Scilab code **Solution 13.3** To obtain Bode plot of given system

```
1 // OS : Windows 7
2 // Scilab : 5.4.1
3 // Toolboxes : Maxima 5.20.1 and ActivePerl 5.20.2
4
5 // Exercise 3 of Lab 13
6 // To obtain Bode plot of given system
7
8 clc
9 close
10
11 s=poly(0, 's')
12 h=syslin('c',31.62*(s*0.125+1)/((s)*(s*2+1)*(s
    *0.044+1)))
13 clf();
14 bode(h,0.1,100)
15 g_margin(h)
16 show_margins(h)
17 p_margin(h)
18 show_margins(h)
```

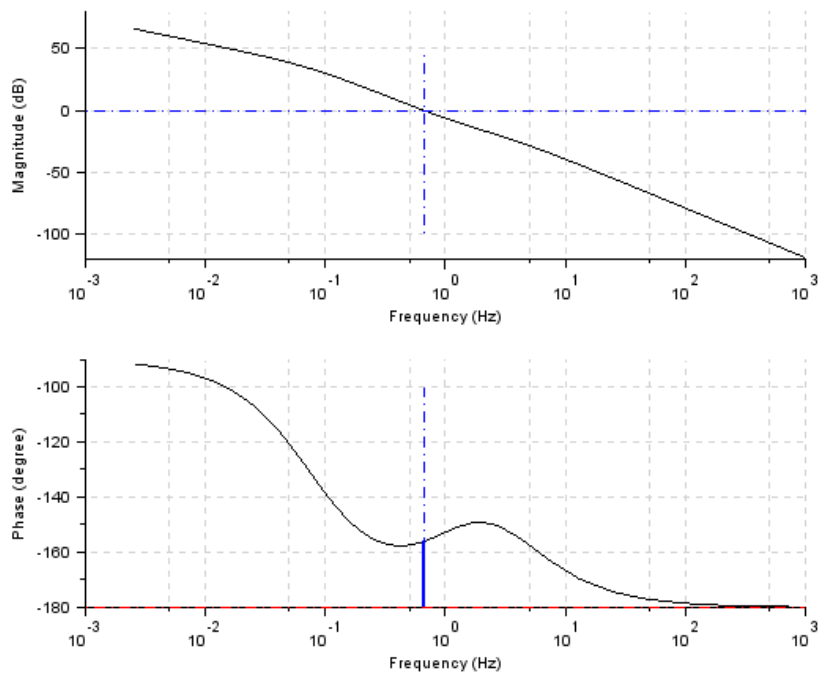

Figure 13.1: To obtain Bode plot of given system

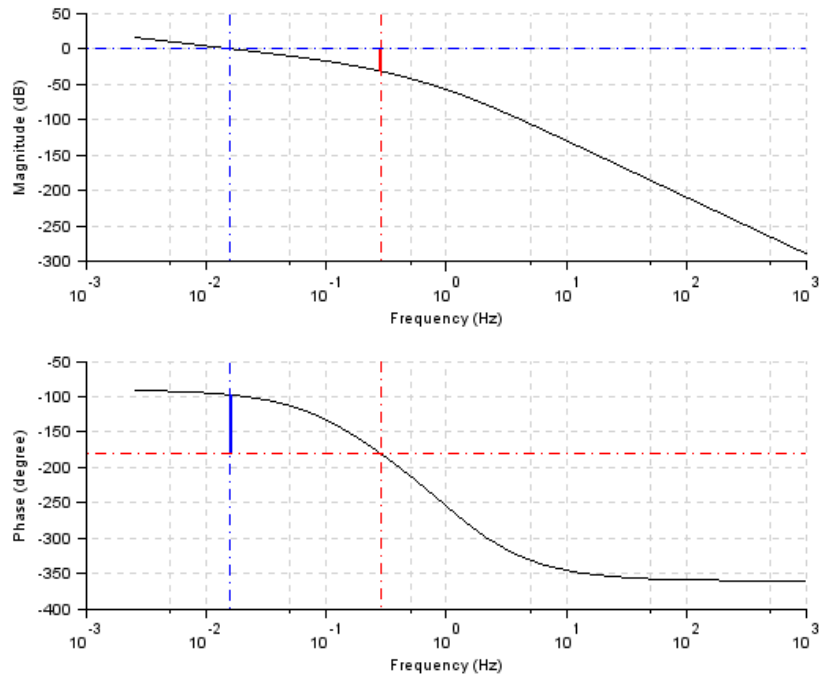

Figure 13.2: To obtain Bode plot of given system

Scilab code Solution 13.4 To obtain Bode plot of given system

```

1 // OS : Windows 7
2 // Scilab : 5.4.1
3 // Toolboxes : Maxima 5.20.1 and ActivePerl 5.20.2
4
5 // Exercise 4 of Lab 13
6 // To obtain Bode plot of given system
7
8 clc

```

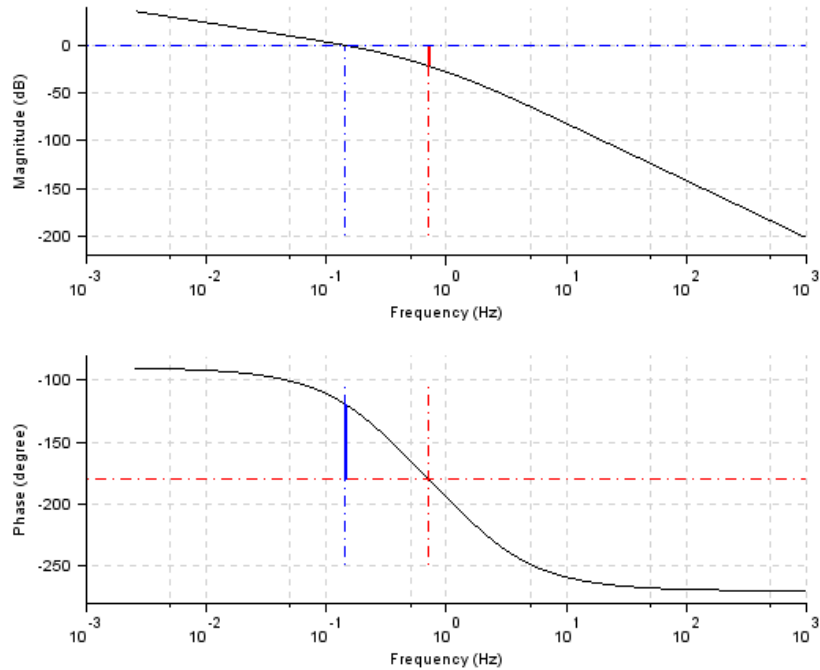

Figure 13.3: To obtain Bode plot of given system

```

9  close
10
11  s=poly(0,'s')
12  h=syslin('c',5/((s)*(s+10)*(s+5)*(s+1)))
13  clf();
14  bode(h,0.1,100)
15  g_margin(h)
16  show_margins(h)
17  p_margin(h)
18  show_margins(h)

```

Scilab code Solution 13.5 To obtain Bode plot of given system

```
1 // OS : Windows 7
2 // Scilab : 5.4.1
3 // Toolboxes : Maxima 5.20.1 and ActivePerl 5.20.2
4
5 // Exercise 5 of Lab 13
6 // To obtain Bode plot of given system
7
8 clc
9 close
10
11 s=poly(0, 's')
12 h=syslin('c', 1/((s)*(s*0.5+1)*(s*0.1+1)))
13 clf();
14 bode(h, 0.1, 100)
15 g_margin(h)
16 show_margins(h)
17 p_margin(h)
18 show_margins(h)
```

Scilab code Solution 13.6 To obtain Bode plot of given system

```
1 // OS : Windows 7
2 // Scilab : 5.4.1
3 // Toolboxes : Maxima 5.20.1 and ActivePerl 5.20.2
4
5 // Exercise 6 of Lab 13
6 // To obtain Bode plot of given system
7
8 clc
9 close
10
```

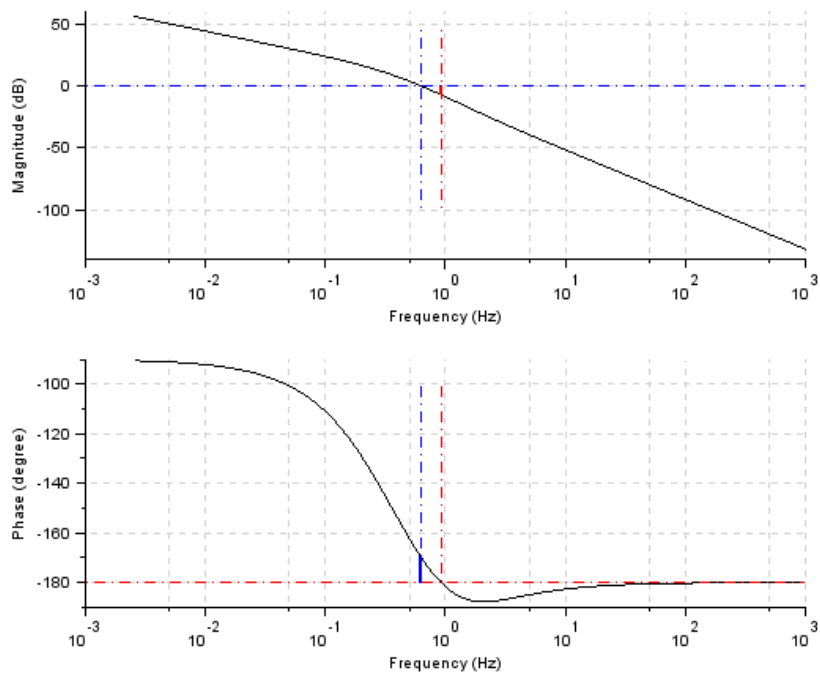

Figure 13.4: To obtain Bode plot of given system

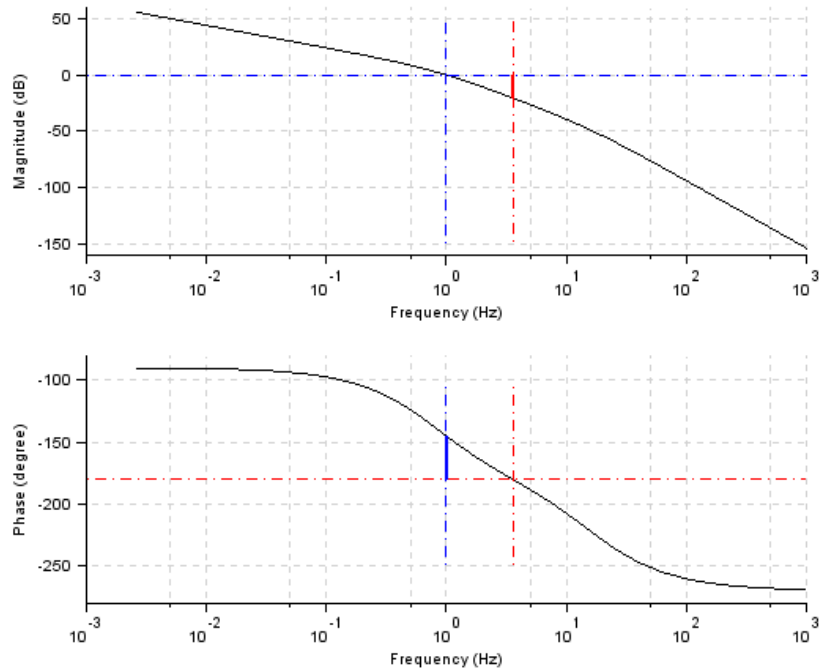

Figure 13.5: To obtain Bode plot of given system

```

11 s=poly(0,'s')
12 h=syslin('c',10*(s+10)/((s)*(s+2)*(s+5)))
13 clf();
14 bode(h,0.1,100)
15 g_margin(h)
16 show_margins(h)
17 p_margin(h)
18 show_margins(h)

```

Scilab code Solution 13.7 To obtain Bode plot of given system

```

1 // OS : Windows 7
2 // Scilab : 5.4.1
3 // Toolboxes : Maxima 5.20.1 and ActivePerl 5.20.2
4
5 // Exercise 7 of Lab 13
6 // To obtain Bode plot of given system
7
8 clc
9 close
10
11 s=poly(0, 's')
12 h=syslin('c', 10/((s)*(s*0.2+1)*(s*0.01+1)))
13 clf();
14 bode(h, 0.1, 100)
15 g_margin(h)
16 show_margins(h)
17 p_margin(h)
18 show_margins(h)

```

Scilab code Solution 13.8 To obtain Bode plot of given system

```

1 // OS : Windows 7
2 // Scilab : 5.4.1
3 // Toolboxes : Maxima 5.20.1 and ActivePerl 5.20.2
4
5 // Exercise 8 of Lab 13
6 // To obtain Bode plot of given system
7
8 clc
9 close
10
11 s=poly(0, 's')
12 h=syslin('c', 10/((s)*(s*0.01+1)*(s*0.1+1)))

```

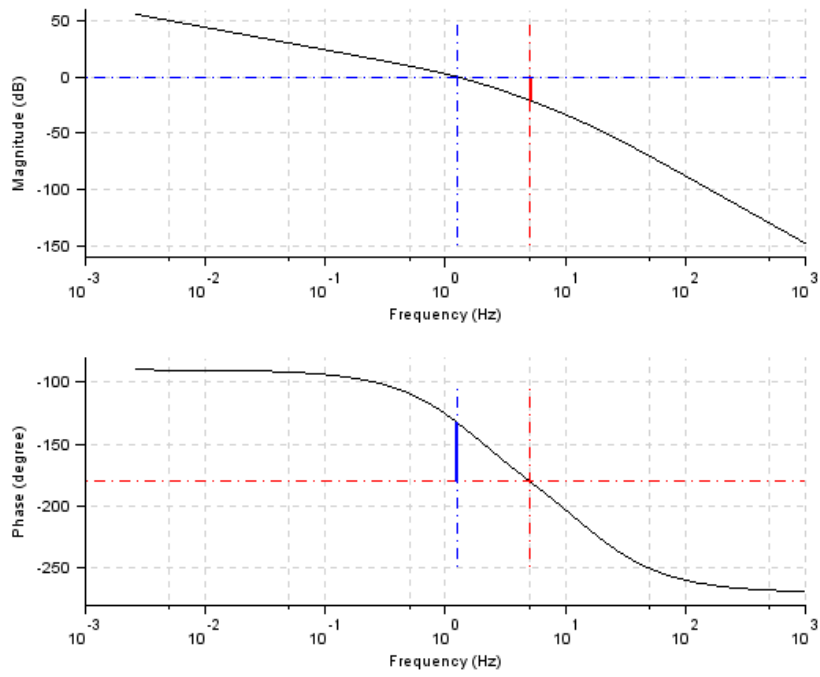

Figure 13.6: To obtain Bode plot of given system

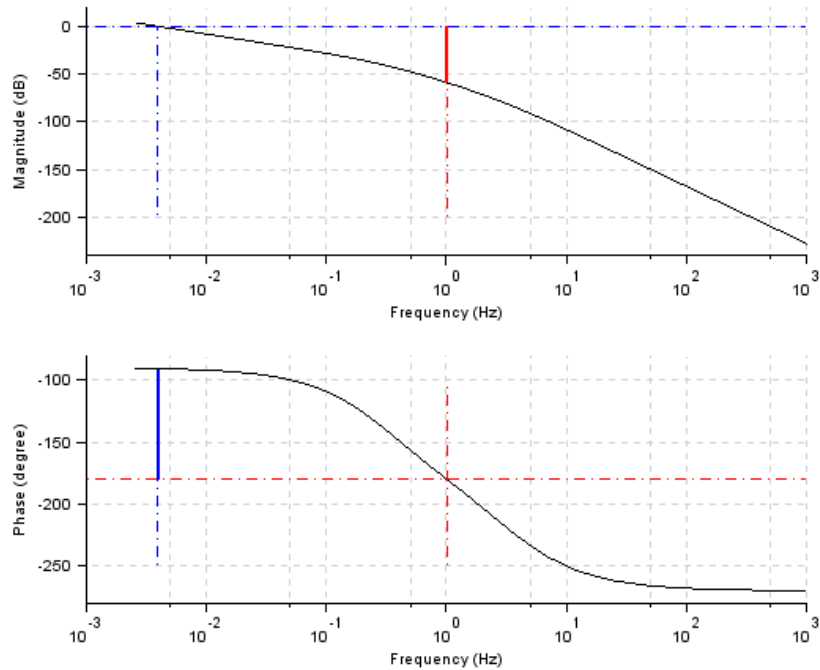

Figure 13.7: To obtain Bode plot of given system

```

13 clf();
14 bode(h,0.1,100)
15 g_margin(h)
16 show_margins(h)
17 p_margin(h)
18 show_margins(h)

```

Scilab code Solution 13.9 To obtain Bode plot of given system

```

1 // OS : Windows 7
2 // Scilab : 5.4.1

```

```

3 // Toolboxes : Maxima 5.20.1 and ActivePerl 5.20.2
4
5 // Exercise 9 of Lab 13
6 // To obtain Bode plot of given system
7
8 clc
9 close
10
11 s=poly(0, 's')
12 h=syslin('c', 0.025/((s)*(s*0.05+1)*(s*0.5+1)))
13 clf();
14 bode(h, 0.1, 100)
15 g_margin(h)
16 show_margins(h)
17 p_margin(h)
18 show_margins(h)

```

Scilab code Solution 13.10 To obtain Bode plot of given system

```

1 // OS : Windows 7
2 // Scilab : 5.4.1
3 // Toolboxes : Maxima 5.20.1 and ActivePerl 5.20.2
4
5 // Exercise 10 of Lab 13
6 // To obtain Bode plot of given system
7
8 clc
9 close
10
11 s=poly(0, 's')
12 h=syslin('c', 50/((s)*(s+1)*(s*0.5+1)))
13 clf();
14 bode(h, 0.1, 100)

```

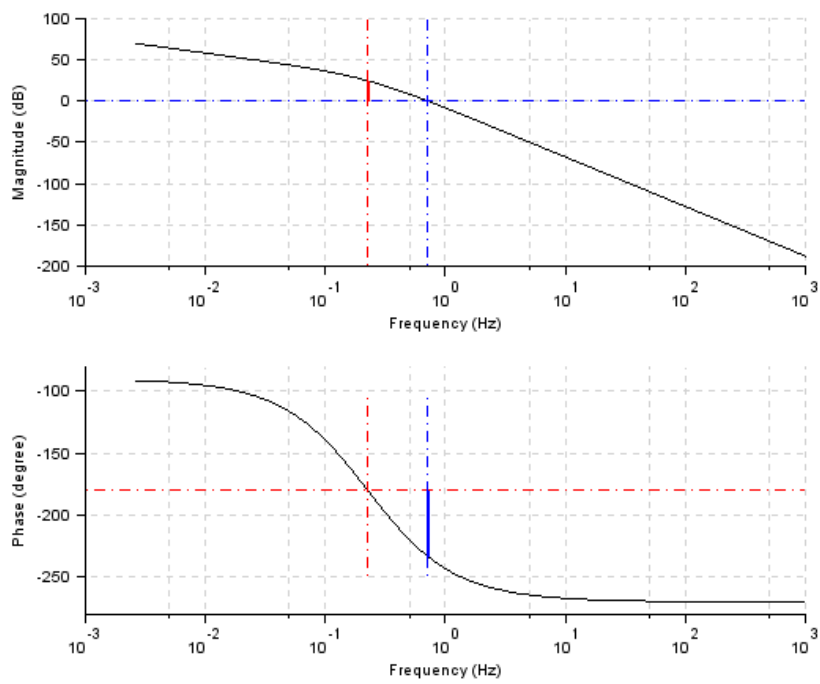

Figure 13.8: To obtain Bode plot of given system

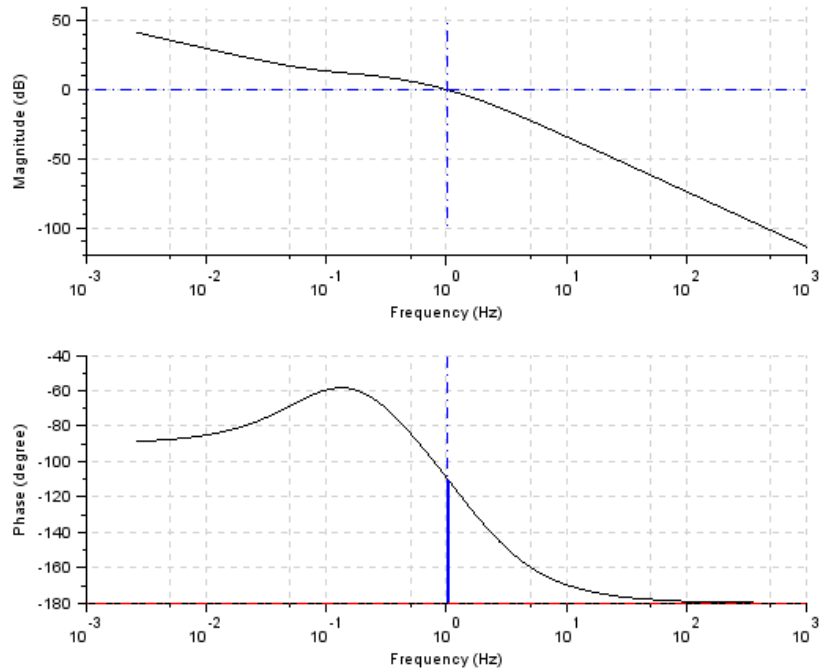

Figure 13.9: To obtain Bode plot of given system

```

15 g_margin(h)
16 show_margins(h)
17 p_margin(h)
18 show_margins(h)

```

Scilab code Solution 13.11 To obtain Bode plot of given system

```

1 // OS : Windows 7
2 // Scilab : 5.4.1
3 // Toolboxes : Maxima 5.20.1 and ActivePerl 5.20.2
4

```

```

5 // Exercise 11 of Lab 13
6 // To obtain Bode plot of given system
7
8 clc
9 close
10
11 s=poly(0, 's')
12 h=syslin('c', (2+4*s)/((s)*(s*0.5+1)*(s*0.1+1)))
13 clf();
14 bode(h,0.1,100)
15 g_margin(h)
16 show_margins(h)
17 p_margin(h)
18 show_margins(h)

```

Scilab code Solution 13.12 To obtain Bode plot of given system

```

1 // OS : Windows 7
2 // Scilab : 5.4.1
3 // Toolboxes : Maxima 5.20.1 and ActivePerl 5.20.2
4
5 // Exercise 12 of Lab 13
6 // To obtain Bode plot of given system
7
8 clc
9 close
10
11 s=poly(0, 's')
12 h=syslin('c', 1/s^3)
13 clf();
14 bode(h,0.1,100)
15 g_margin(h)
16 show_margins(h)

```

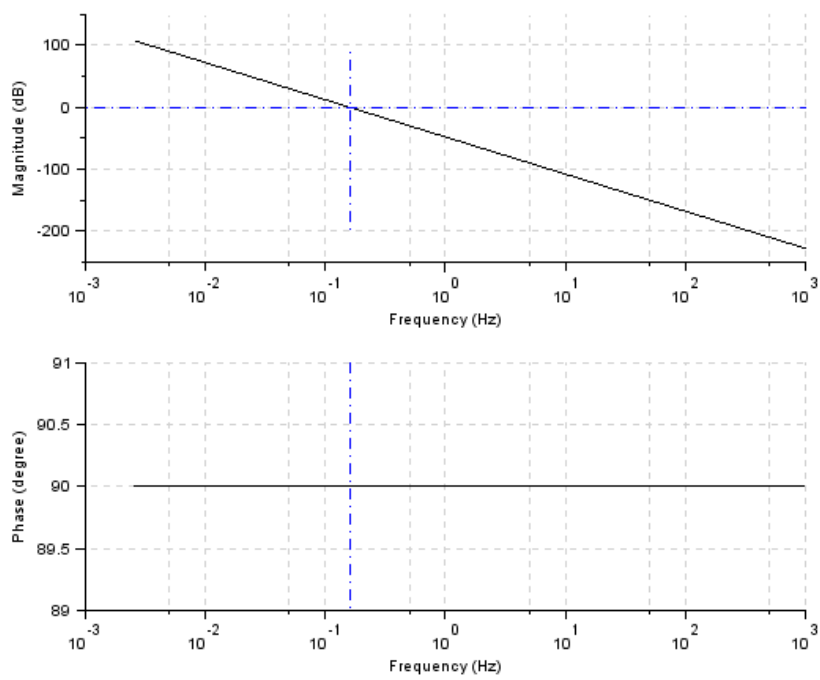

Figure 13.10: To obtain Bode plot of given system

```
17 p_margin(h)
18 show_margins(h)
```
